



Guide to Fire Safety in Houses in Multiple Occupation



This guide outlines the fire safety provisions recommended for HMOs in Hertfordshire and is based upon the national guidance produced by LACORS.

Guide For Owners, Agents and Managers of HMOs

Foreword

Local Authorities of Hertfordshire with Hertfordshire Fire and Rescue Service have produced this document to provide owners, managers, letting agents, and contractors with user friendly, accessible information to help ensure tenants of houses in multiple occupation are housed in safe and high quality accommodation.

This document contains general advice and suggested specifications; and whilst the examples and advice given is based on the national fire safety guidance produced by LACORS (Housing – Fire Safety available at www.lacors.gov.uk/lacors/upload/19175.pdf), both the national guide and this document are only guidance and the requirements in individual properties may vary dependent on the risks presented. If you have any questions or believe your property does not fit comfortably within one of the examples given in this document you should contact your Local Authority for further advice. It will probably be necessary to carry out a risk assessment to determine what fire precautions are necessary and additional advice on how to do this is provided in Part 7 on page 42.

The Government believes that safe and properly managed Houses in Multiple Occupation (HMOs) fulfil an important function in the private rented housing market. HMOs have a particular role in providing affordable accommodation in areas of high housing demand where other rents may be high.

We aim to encourage the supply of good quality private rented homes, and provide, and facilitate, information and training for landlords.

We would like to acknowledge the assistance of “Homestamp”, a partnership consortium in the West Midlands in the preparation of this document. Their website is:

www.homestamp.com

For further information or assistance on HMOs please contact your local Environmental Health department. You may also wish to study the national fire safety guide available to download at: <http://www.lacors.gov.uk/lacors/upload/19175.pdf>

The information contained in this guide is based on that provided by LACORS in “Housing – Fire Safety. Guidance on fire safety provisions for certain types of existing housing”, and was correct at the time of publication. However legislation may change over time and guidance is subject to revision. This guidance has been produced collaboratively by Hertfordshire Local Authorities and Hertfordshire Fire & Rescue Authority, and is intended to illustrate good practice. It is not to be seen as a definitive interpretation of statutory legislation, which can only be done by the Courts or Tribunals.

Contents

Purpose of this guide and how to use it	Page 5
Part 1	
What is an HMO	Page 6
Why is fire safety important?	Page 6
Part 2	
Fire prevention	Page 7
Part 3	
General principles for fire precautions	Page 9
Part 4 - Example Layouts and general specifications	
Key to plans	Page 11
Plan 1, two storey with shared cooking facilities	Page 12
Plan 2, two storey with individual cooking facilities	Page 14
Plan 3, three storey with individual cooking facilities	Page 16
Plan 4, three storey with shared cooking facilities	Page 18
Plan 5, two storey with basement	Page 20
Plan 6, three storey above commercial premises	Page 22
Part 5	
Management and Maintenance of Fire Safety	Page 24
Part 6 – Technical Specifications	
Fire detection and alarm systems	Page 28
Model certificate for alarm systems	Page 31
Emergency lighting	Page 32
Signs and notices	Page 32
Fire resistance of walls and partitions	Page 32
Upgrading of floors and ceilings	Page 32
Fire resisting glazing	Page 34
Safety glazing	Page 38
Additional escape route separation	Page 39
Fire doors	Page 40
Escape windows	Page 40
Part 7	
Fire risk assessment	Page 42
Example maintenance record	Page 47
Part 8	
Sprinkler systems	Page 50
Part 9	
Glossary	Page 51
Blank fire risk assessment form	Page 55

Purpose of this Guide

This document does not set prescriptive or new standards, it gives recommendations and guidance for use when assessing and determining the adequacy of fire precautions. This guide details property layouts for HMOs commonly found in Hertfordshire and details the recommended fire safety measures that will usually be required.

The Housing Act 2004 takes the view that someone with overall control of the house, (i.e. the owner, landlord or manager) must take steps to protect everyone living in it. In standard layout and use properties it is likely that completion of the works suggested in this document will suffice. However, it may be necessary for additional or different works to be undertaken in particular circumstances. If you have any questions, and in particular if the layout of your property is not shown in this document or the use is different to that explained you should contact your local Environmental Health department for advice prior to undertaking any works.

Alternatives to these suggested specifications will be considered if they provide a sufficient level of protection to residents. It is likely that a fire risk assessment will need to be completed in order to demonstrate this. The Council and the Fire Service must agree to any alternative solutions. An example of alternative fire safety precautions is installation of a sprinkler system – an example specification of this is included at the back of this document.

There are further requirements under housing legislation, for example, space and amenity standards which also need to be met. In particular, three storey HMOs with five or more residents will need to be licensed by your Local Authority. For certain conversion, alteration or improvement works you may require planning permission or approval from Building Control, you should always seek advice from the Council prior to converting or renovating a property. Licensed HMOs are also required to produce a Fire Safety Risk Assessment. This is good practice for all HMOs and further guidance and examples can be sought from your Local Authority or Hertfordshire Fire and Rescue Service.

What is in this Guide?

Part 1 outlines what an HMO is for Housing legislation purposes and explains why fire safety is important.

Part 2 details the fire prevention measures you should take even before you complete any upgrading works. It is recommended that you implement these measures in single family dwellings as well as HMOs.

Part 3 outlines the general principles of fire precautions in HMOs.

Part 4 gives examples of standard layouts of properties and outline specifications of what fire precaution works are required.

Part 5 details the maintenance required once upgrading is completed.

Part 6 gives the technical specification for the different requirements of upgrading – this is lengthy and you do not need to read all of this until you begin your upgrading.

Part 4 and part 6 can be copied and given to your contractors to aid in specifying the requirements of the works.

Part 7 Routine Checks

Part 8 Water Suppression Systems Overview

Part 9 Glossary

Part 1 - What is an HMO and why is fire safety important?

Houses in Multiple Occupation (HMOs)

Definition of an HMO:

A House in Multiple Occupation is a building or part of a building (e.g. a flat) that is:

- a) occupied by more than one household who share an amenity such as a bathroom, toilet or cooking facilities; or**
- b) building converted into self contained flats that do not meet the 1991 Building Regulations, where at least one third of the flats are occupied under short tenancies.**

The term *occupied* means that it is the occupants' only or main residence, but it does also include properties where students live in term time only. People are classed as separate households if they are not family members or co-habiting couples. There are exemptions to these rules and further information can be obtained from your Environmental Health department.

This document does not detail fire precaution recommendations for purpose built self contained flats. However the principles of early warning and protected escape routes still apply. You should contact your Local Authority for advice in relation to these properties.

Why is fire safety important?

HMO accommodation has often been created by sub division of larger properties into smaller units and this can increase the risk that a fire will occur. In addition, the means of escape may have been compromised in the process of redevelopment making it less likely that occupants will get out of the building safely should a fire occur. Deaths and injuries from fires in HMOs are proportionately higher than in single family homes.

The main reasons for insisting on fire precautions in Houses in Multiple Occupation (HMOs) are to provide early warning, and to stop the smoke and fire spreading to parts of the property before other residents have the chance to escape.

Part 2 - Fire Prevention

The most important action you can take as a property manager is to try and prevent fires. Whilst the advice given in this booklet has mainly been concerned with methods of warning residents of a fire and preventing the spread of the fire to enable them to escape; fire precaution measures can never guarantee absolute safety for residents, nor prevent extensive property damage.

The most important steps that you, as an owner or manager can take to minimise the risk of a fire are:

Electrics	<p>Make sure that the electrical circuits, fittings and equipment throughout the house are in good condition. Have the electrical installation checked regularly by a competent electrician (NICEIC or ECA approved) and act quickly on any recommendations that are made.</p> <p>The electrician's report will tell you the date on which the installation should be checked again. Install circuit breakers and prevent overloading of sockets by ensuring that adaptors are not needed.</p> <p>If you buy new electrical equipment, make sure that it bears the CE mark, either on the equipment itself, or on the box, to show that it complies with legal standards. The purchase of second hand electrical goods is not recommended.</p>
Gas	<p>Have the gas installation (i.e. the gas pipework, meters, gas fires, cookers, boilers, water heaters and flues) checked, and serviced at least once a year by a Gas Safe registered gas fitter. This is a legal requirement under the Gas Safety (Installation and Use) Regulations. You must give a copy of the safety certificate to each resident within 28 days, and give a copy to new residents before they move in.</p>
Location	<p>Make sure that heaters and cookers are fixed in a position where they will not set fire to curtains, bedding or furnishings.</p>
Furniture	<p>Make sure that all upholstered furniture that you, as the landlord, provide (such as settees, armchairs, bed bases and mattresses) has sewn-in labels showing that it has fire-resistant filling and covers. This is a legal requirement under the Furniture and Furnishings (Fire)(Safety) Regulations 1988 and the Furniture and Furnishings (Fire)(Safety) (Amendment) Regulations 1993.</p>
Flammable materials	<p>Prohibit the use of portable gas or paraffin heaters in the house. Do not store highly flammable materials in the house (such as paint, thinners, LPG cylinders, paraffin or petrol).</p>
Combustible items	<p>Do not store large quantities of combustible materials such as cardboard boxes or newspapers, in understairs cupboards, cellars, or in the loft.</p>

Inform your residents of the following information and make sure they understand the importance of:

The dangers of:

- smoking in bed or when drowsy
- careless use of candles or joss sticks
- overloading electrical sockets
- having trailing cables
- leaving a chip pan or frying pan unattended, or over-full of oil or fat
- placing clothes to dry over or near heaters

and the importance of a bedtime fire safety routine:

- turning off the cooker
- unplugging electrical appliances (except those designed to remain on)
- making sure that no cigarettes or candles are left burning
- closing all doors

You should advise residents that in the event of a fire:-

- Do not attempt to fight fires that have already taken hold – evacuate yourself from the house. If you share the house with other people sound the alarm as you make your escape.
- Do not try to rescue belongings or pets. Your life and the lives of other residents are too precious to risk.
- Telephone the Fire Brigade on 999 immediately from a place of safety. Speak slowly and try to be calm answering the questions you are asked. If you think there may be someone left in the building inform the 999 operator.

A template leaflet/poster may be available from your Local Authority.

Part 3 - General Principles for Fire Precaution Standards

The following diagram illustrates the general principles of fire precautions in a representative house:

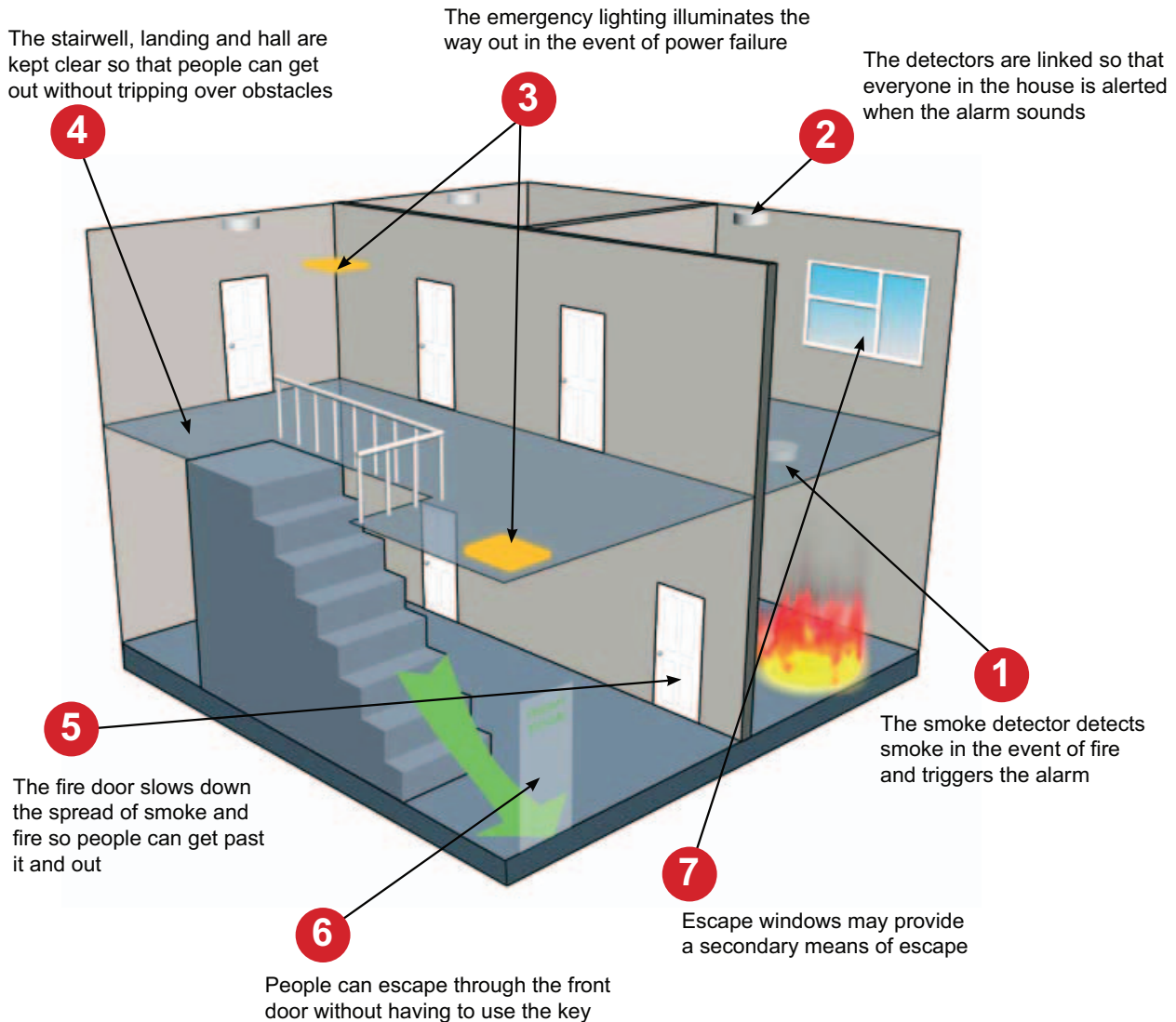

The HMO's design, construction and condition must limit the spread of fire and smoke and provide a safe and ready means of escape. There must be adequate fire protection to the means of escape and between each unit of accommodation, with appropriate detection and alarm systems provided. Emergency lighting and fire blankets shall be provided where necessary.

1. Every risk room (bedroom, living room, kitchen) and circulation space needs a mains wired detector/alarm. These will detect fires at the earliest opportunity and ensure that warning is sounded.
2. The detectors normally need to be linked so that everyone in the house is alerted when the alarm sounds.
3. Emergency lighting illuminates the escape route to show persons the way out if the electricity supply is interrupted.
4. The stairwell, landing, and hall are kept clear of obstruction so that people can get out without tripping.
5. The escape route shall be protected to ensure people can exit the property safely. Generally, this will mean the partitions from risk rooms to the escape route giving 30 minutes fire resistance. Between rooms or in certain low risk premises partitions may be acceptable if they are of sound traditional construction - see Plans & Glossary.

6. All risk rooms (bedroom, living room, kitchen) need 30 minute fire resisting doors with smoke and heat seals and self-closing devices. The fire door slows down the spread of smoke and fire so people can move past it to exit the house. Fire doors are provided to protect the route of escape and should never be wedged open.
7. The methods of locking or fastening risk rooms and escape room doors should not prevent them from being opened internally without the use of a key.
8. Fire blankets and fire extinguishers can be useful in tackling small fires, and preventing their uncontrolled spread, but on balance it is best to encourage people to get out of the house quickly and call the Fire Service. There are injuries every year as a result of ineffective or inappropriate use of equipment. Where equipment is provided, all residents must receive proper instruction in the use of it. Therefore, whilst fire blankets should be provided to all cooking facilities normally there will be no requirement for fire extinguishers.
9. Where a basement or commercial premises are present, these shall be separated from the residential area by structure including doors providing 60 minutes fire protection. See plan 5 and 6 of Part 4. Where an automatic fire detection system includes the basement area the level of separation between the basement and the rest of the house need only be 30 minutes.

Travel distances

Travel distances within HMOs are an important matter. In the event of fire, occupiers need to be reasonably sure that they can reach a place of safety within reasonable time. The layout of the premises needs to be such that occupiers can quickly find their way across the room they are in and then through any protected route to the final exit. This must be achieved despite possible heat, flames and most importantly smoke. Smoke is often toxic but can also reduce visibility both by fogging and by causing irritation to the eyes. Occupiers need to be able to get through the escape route with a minimum of exposure to these hazards particularly by inhalation.

Like most elements of fire safety, judging the adequacy of travel distances is a matter of risk assessment and needs to be considered along with all other risks.

As a guideline however:

The distance between any point on the premises and a place of relative safety should ideally be a maximum of 9 metres. A place of relative safety would, for example, be a protected route within the building.

In HMOs without a protected route (for example in smaller two storey shared houses) the travel distance will generally need to be calculated from the furthest corner of the most distant bedroom to the front door.

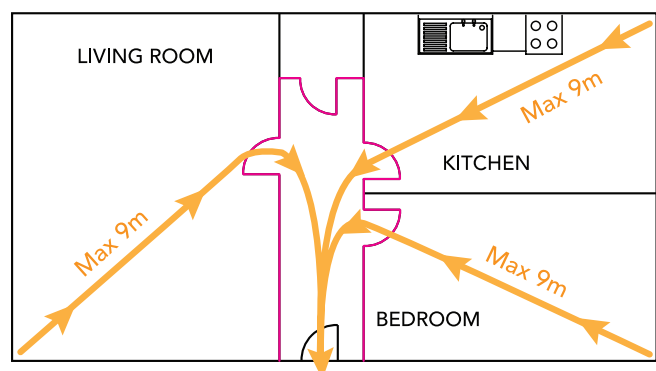

Place of relative safety or protected route

Where 9m travel distance is exceeded, landlords should consider this as an item of additional risk. Some examples of the ways that excessive travel distances can be offset are:















- provision of alternative escape means (e.g. an escape window) or routes;
- provision of portable fire fighting equipment;
- provision of a suppression system;
- upgrading the passive fire resistance.

Premises converted after 1991 with full Building Regulation Approval should already comply with travel distance requirements.

Part 4 - Detailed Fire Precautions Required

The following pages include some typical examples of house layouts and recommended works. Remember that these are suggested ways of complying with the basic principles. There may be other options and you should discuss these with your Local Authority.

Key to plans

	30 minute fire resistance (wall/door/ partition etc..)
	Sound traditional construction
	1 hour fire resistance (wall/door/ partition etc..)
	Smoke Detector - interlinked, mains wired with battery back up
	Heat Detector - interlinked mains wired with battery back up
	Smoke Detector - independent mains wired. (recommended hush facility.)
	Fire Blanket
	Emergency Light
	Control Panel - for fire detection system
	Break Glass Point
	Emergency Escape Window
	Loft hatch – 30 minute fire resistance
	Electric meter to be boxed in to 30 minute fire resistance
	Gas meter to be boxed in to 30 minute fire resistance

Outline requirements for example property - Plan 1

Detection/ Warning	A system of mains powered interlinked automatic smoke and heat detectors to form a grade D LD2 system in accordance with BS 5839 part 6 (or equivalent). System to incorporate interlinked smoke alarms with integral battery back-up throughout the escape route. Interlinked smoke alarms with integral battery back-up in each bedroom, communal living room, and cellar. Interlinked heat alarms with integral battery back-up in communal kitchens. Refer to page 29 for technical specification.
Call Points	Not required.
Control Panel	Not required.
Emergency Lighting	Conventional lighting is required throughout the escape route. Emergency lighting maybe appropriate if the route is complex or there is no effective borrowed light. The requirement for, and the degree of emergency lighting will depend on the design of the property and the location of the escape route and form part of the overall Fire Risk Assessment. Where considered necessary it must be designed and installed in accordance with BS 5266 part 1 (or equivalent). Refer to page 32 for technical specification.
Escape Route	The escape route should allow occupants from all parts of the building to reach a place of safety outside without passing through a higher fire risk area. The route should be kept free of obstructions and combustible materials at all times, and the walls and ceilings should be free of flammable materials such as polystyrene ceiling tiles and heavy flock wall paper. At least 30 minute fire resistance should be provided to the route as indicated by red on the accompanying plan. There is no requirement for additional fire separation between rooms, but the walls and floors should be of sound traditional construction. Electric and Gas meters located in the escape route should either be re-located or contained within fire resisting construction to provide at least 30 minute fire resistance. Refer to pages 32-39 for specifications relating to fire resisting construction.
Fire Doors	A fire door of at least 30 minute fire resistance must be installed in each doorway leading onto the escape route, except bathrooms and WC's (unless they contain a fire risk such as a boiler). Refer to page 40 for specification of fire doors.
Security of Doors	Security devices on bedrooms and final exit doors must be capable of being opened from the inside without the use of keys, i.e. Yale type or thumb turn locks.
Fire Blankets	A fire blanket should be provided in each area where there are cooking facilities, and be wall mounted 1.5m high adjacent to an exit door and away from the cooking appliance. These must comply with BS 6575 (or equivalent).
Fire Extinguishers	Where the risk assessment indicates that fire extinguishers are required they shall be multipurpose extinguishers and shall be located as requested by the risk assessment. If provided they shall be maintained in working order and residents instructed in their use.
Other Recommendations	Polystyrene ceiling tiles should not be used within the premises. Portable heaters using gas cylinders or flammable liquids should not be used or stored in the premises. Generally signage relating to fire precautions is not necessary. However fire doors across escape routes, communal kitchens, and boiler rooms should be marked 'Fire door keep shut' Reference should be made to 'The Management of Houses in Multiple Occupation (England) Regulations 2006' – in particular regulation 4 relates to the maintenance of fire fighting equipment and alarms.

Plan 1, House Type: Typical two storey house with Shared Cooking Facilities.

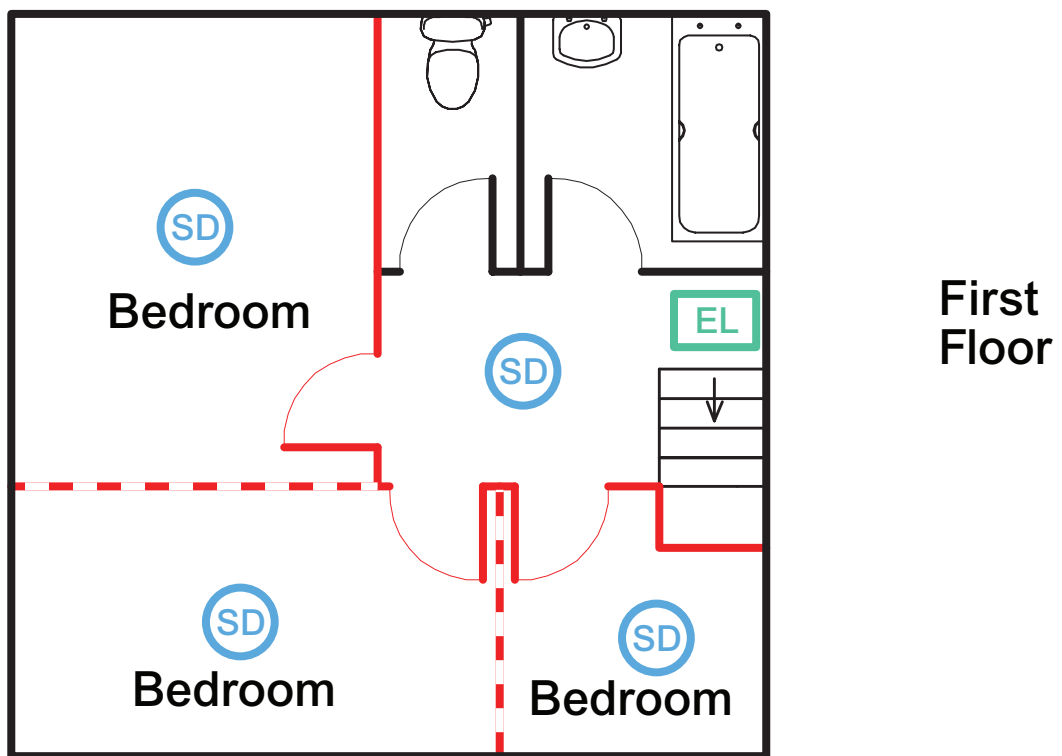

Outline requirements for example property - Plan 2

Detection/ Warning	A system of mains powered interlinked automatic smoke and heat detectors to form a Grade D LD2 system in accordance with BS 5839 Part 6 (or equivalent). System to incorporate interlinked smoke alarms with integral battery back-up throughout the escape route, any communal living room and cellar. Interlinked heat alarms with integral battery back-up in each bedroom containing cooking facilities. Additional non-interlinked smoke alarms with integral battery back-up in each bedroom. It is recommended that these have a hush facility. Refer to page 29 for technical specification.
Call Points	Not required.
Control Panel	Not required.
Emergency Lighting	Conventional lighting is required throughout the escape route. Emergency lighting maybe appropriate if the route is complex or there is no effective borrowed light. The requirement for, and the degree of emergency lighting will depend on the design of the property and the location of the escape route and form part of the overall Fire Risk Assessment. Where considered necessary it must be designed and installed in accordance with BS 5266 part 1 (or equivalent). Refer to page 32 for technical specification.
Escape Route	The escape route should allow occupants from all parts of the building to reach a place of safety outside without passing through a higher fire risk area. The route should be kept free of obstructions and combustible materials at all times, and the walls and ceilings should be free of flammable materials such as polystyrene ceiling tiles and heavy flock wall paper. At least 30 minute fire resistance should be provided to the route as indicated by red on the accompanying plan. There is no requirement for additional fire separation between rooms, but the walls and floors should be of sound traditional construction. Electric and Gas meters located in the escape route should either be re-located or contained within fire resisting construction to provide at least 30 minute fire resistance. Refer to pages 32-39 for specifications relating to fire resisting construction.
Fire Doors	A fire door of at least 30 minute fire resistance must be installed in each doorway leading onto the escape route, except bathrooms and WC's (unless they contain a fire risk such as a boiler). Refer to page 40 for specification of fire doors.
Security of Doors	Security devices on bedrooms and final exit doors must be capable of being opened from the inside without the use of keys, i.e. Yale type or thumb turn locks.
Fire Blankets	A fire blanket should be provided in each area where there are cooking facilities, and be wall mounted 1.5m high adjacent to an exit door and away from the cooking appliance. These must comply with BS 6575 (or equivalent).
Fire Extinguishers	Where the risk assessment indicates that fire extinguishers are required they shall be multipurpose extinguishers and shall be located as requested by the risk assessment. If provided they shall be maintained in working order and residents instructed in their use.
Other Recommendations	Polystyrene ceiling tiles should not be used within the premises. Portable heaters using gas cylinders or flammable liquids should not be used or stored in the premises. Generally signage relating to fire precautions is not necessary. However fire doors across escape routes, communal kitchens, and boiler rooms should be marked 'Fire door keep shut'. Reference should be made to 'The Management of Houses in Multiple Occupation (England) Regulations 2006' – in particular regulation 4 relates to the maintenance of fire fighting equipment and alarms.

Plan 2, House Type: Typical two storey house with cooking facilities in each let.

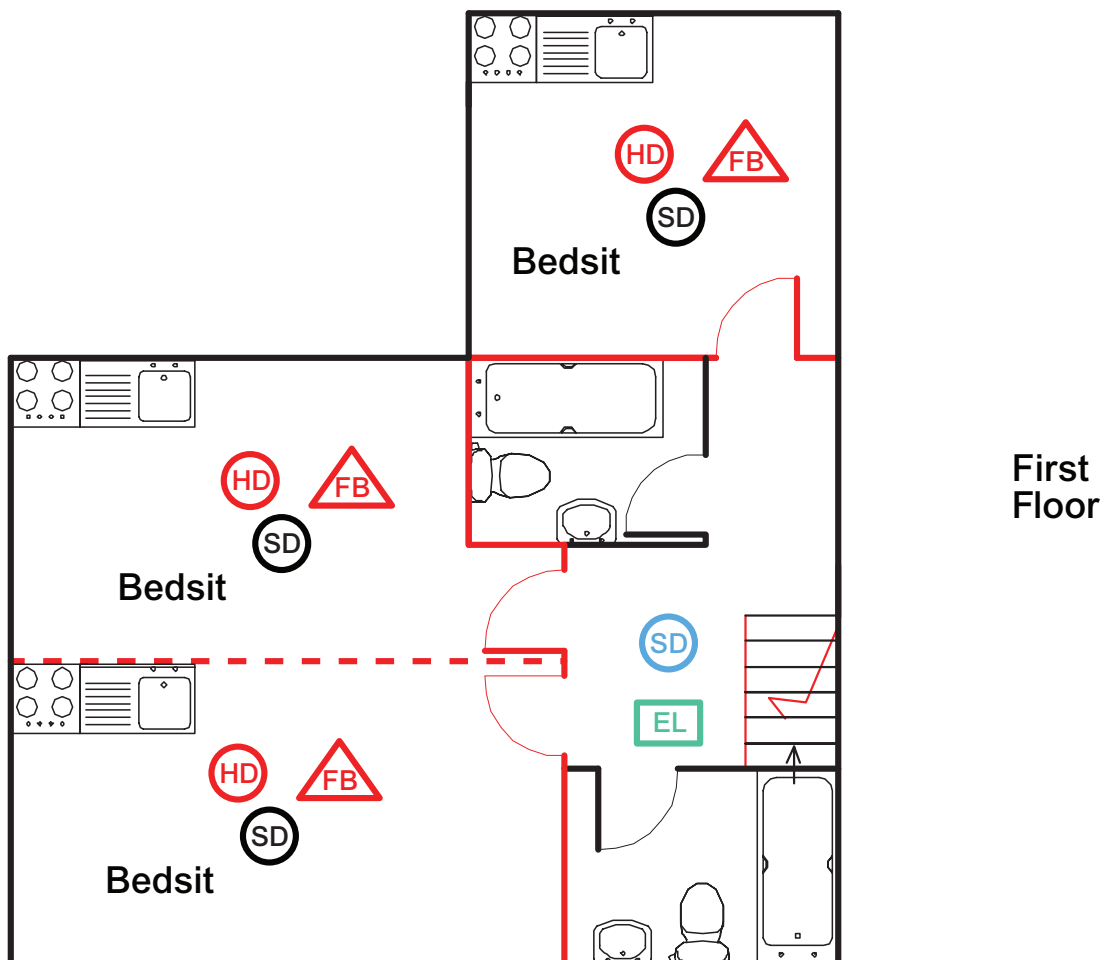
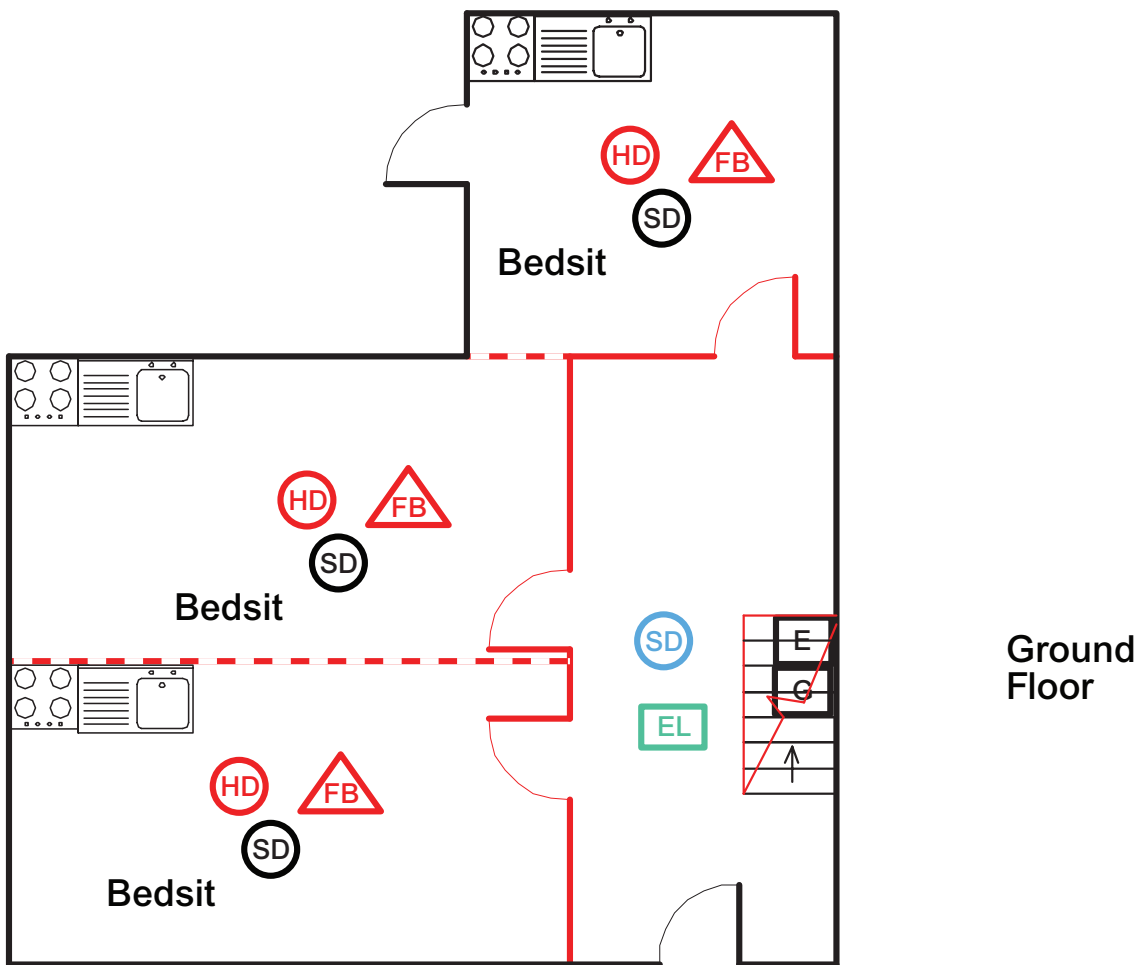

Outline requirements for example property - Plan 3

Detection/ Warning	A system of mains powered interlinked automatic smoke and heat detectors to form a grade A LD2 system in accordance with BS 5839 part 6 (or equivalent). System to incorporate interlinked smoke alarms with integral battery back-up throughout the escape route, any communal living room, and cellar. Interlinked heat alarms with integral battery back-up in each bedroom containing cooking facilities. Additional non-interlinked smoke alarms with integral battery back up in each bedroom. It is recommended that these have a hush facility. Refer to page 28 for technical specification.
Control Panel	Must conform to BS EN 54: Part 2. Must be located in an easily accessible position within the escape route.
Call Points	Manual break glass points should be installed in numbers and positions determined by fire risk assessment. At least one should be installed close to the final exit of the escape route.
Emergency Lighting	To be provided in accordance with the current BS 5266 Part 1 (or equivalent) to cover the protected escape route. Location of light fittings to be determined by the design/installing engineer. See page 32 for further information.
Escape Route	The escape route should allow occupants from all parts of the building to reach a place of safety outside without passing through a higher fire risk area. The route should be kept free of obstructions and combustible materials at all times, and the walls and ceilings should be free of flammable materials such as polystyrene ceiling tiles and heavy flock wall paper. At least 30 minute fire resistance should be provided to the route as indicated by red on the accompanying plan. There is no requirement for additional fire separation between rooms, but the walls and floors should be of sound traditional construction. Electric and Gas meters located in the escape route should either be re-located or contained within fire resisting construction to provide at least 30 minute fire resistance. Refer to pages 32-39 for specifications relating to fire resisting construction.
Fire Doors	A fire door of at least 30 minute fire resistance must be installed in each doorway leading onto the escape route, except bathrooms and WC's (unless they contain a fire risk such as a boiler). Refer to page 40 for specification of fire doors.
Security of Doors	Security devices on bedrooms and final exit doors must be capable of being opened from the inside without the use of keys, i.e. Yale type or thumb turn locks.
Fire Blankets	A fire blanket should be provided in each area where there are cooking facilities, and be wall mounted 1.5m high adjacent to an exit door and away from the cooking appliance. These must comply with BS 6575 (or equivalent).
Fire Extinguishers	Where the risk assessment indicates that fire extinguishers are required they shall be multipurpose extinguishers and shall be located as requested by the risk assessment. If provided they shall be maintained in working order and residents instructed in their use.
Other Recommendations	Polystyrene ceiling tiles should not be used within the premises. Portable heaters using gas cylinders or flammable liquids should not be used or stored in the premises. Generally signage relating to fire precautions is not necessary. However fire doors across escape routes, communal kitchens, and boiler rooms should be marked 'Fire door keep shut'. Reference should be made to 'The Management of Houses in Multiple Occupation (England) Regulations 2006' – in particular regulation 4 relates to the maintenance of fire fighting equipment and alarms.

Plan 3, House Type: Typical three storey HMO with cooking in each of the lets.

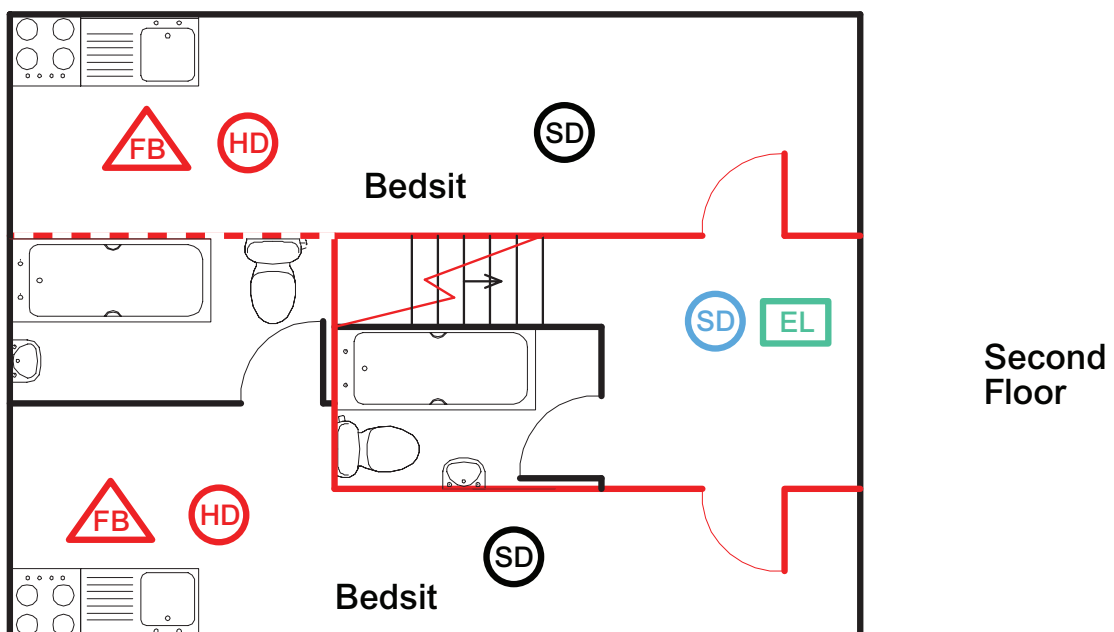
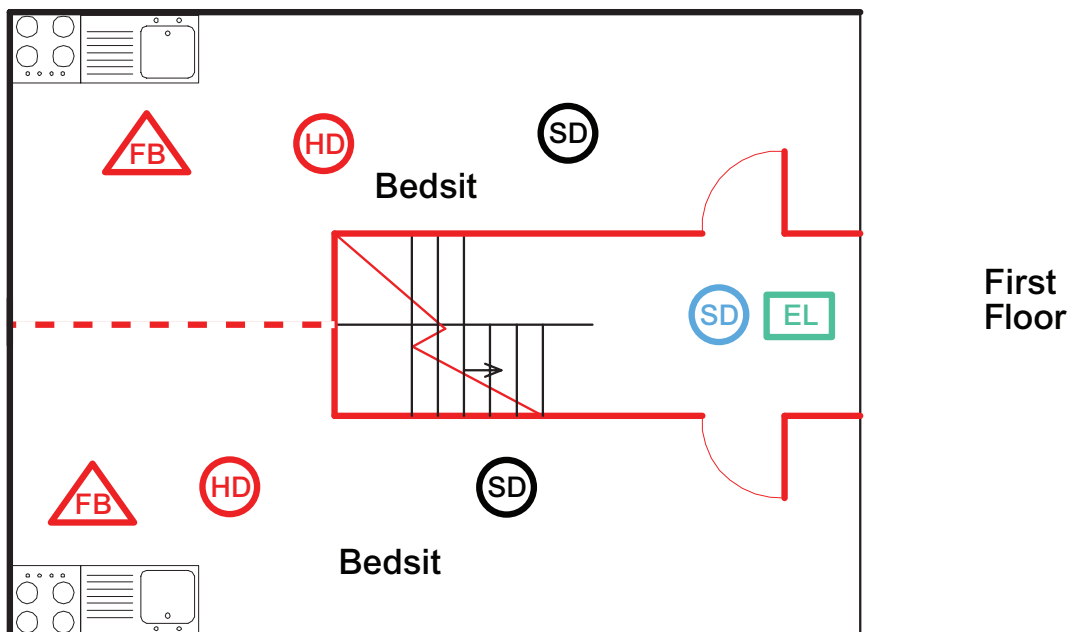
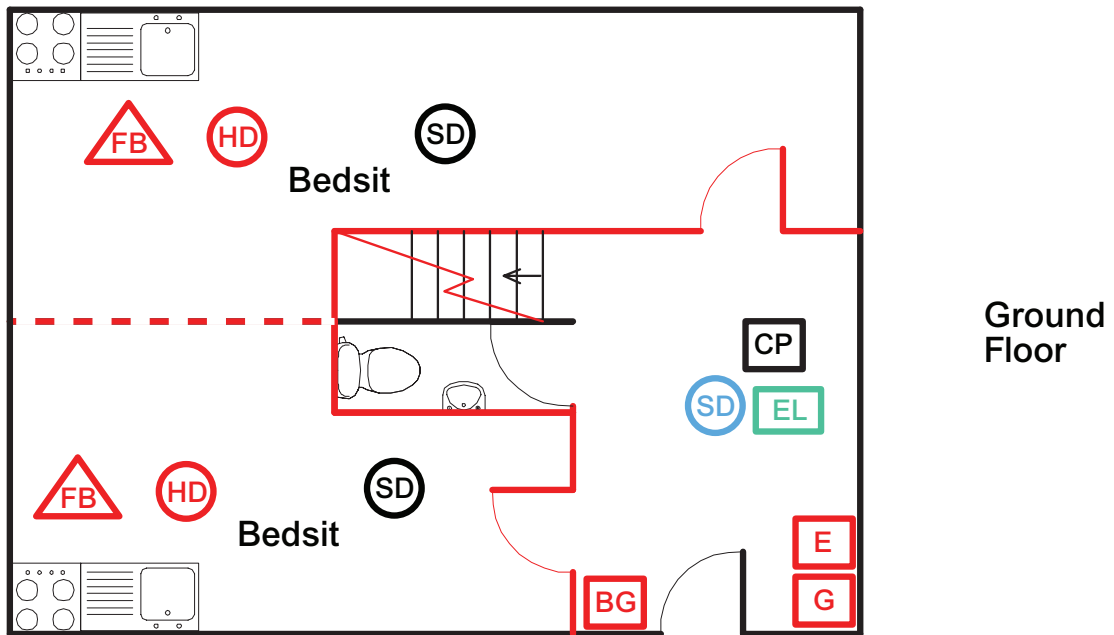

Outline requirements for example property - Plan 4

Detection/ Warning	A system of mains powered interlinked automatic smoke and heat detectors to form a Grade A LD2 system in accordance with BS 5839 Part 6 (or equivalent). System to incorporate interlinked smoke alarms with integral battery back-up throughout the escape route, in each bedroom, communal living room and cellar. Interlinked heat alarms with integral battery back-up in communal kitchens. Refer to page 28 for technical specification.
Call Points	Manual break glass points should be installed in numbers and positions determined by fire risk assessment. At least one should be installed close to the final exit of the escape route.
Control Panel	Must conform to BS EN 54: Part 2. Must be located in an easily accessible position within the escape route.
Emergency Lighting	Conventional lighting is required throughout the escape route. Emergency lighting maybe appropriate if the route is complex or there is no effective borrowed light. The requirement for, and the degree of emergency lighting will depend on the design of the property and the location of the escape route and form part of the overall Fire Risk Assessment. Where considered necessary it must be designed and installed in accordance with BS 5266 part 1 (or equivalent). Refer to page 32 for technical specification.
Escape Route	The escape route should allow occupants from all parts of the building to reach a place of safety outside without passing through a higher fire risk area. The route should be kept free of obstructions and combustible materials at all times, and the walls and ceilings should be free of flammable materials such as polystyrene ceiling tiles and heavy flock wall paper. At least 30 minute fire resistance should be provided to the route as indicated by red on the accompanying plan. There is no requirement for additional fire separation between rooms, but the walls and floors must be of sound traditional construction. Electric and gas meters located in the escape route should either be re-located or contained within fire resisting construction to provide at least 30 minute fire resistance. Refer to pages 32-39 for specifications relating to fire resisting construction.
Fire Doors	A Fire door of at least 30 minute fire resistance must be installed in each doorway leading onto the escape route, except bathrooms and WC's (unless they contain a fire risk such as a boiler). Refer to page 40 for specification of fire doors.
Security of Doors	Security devices on bedrooms and final exit doors must be capable of being opened from the inside without the use of keys, i.e. Yale type or thumb turn locks.
Fire Blankets	A fire blanket should be provided in each area where there are cooking facilities, and be wall mounted 1.5m high adjacent to an exit door and away from the cooking appliance. These must comply with BS 6575 (or equivalent).
Fire Extinguishers	Where the risk assessment indicates that fire extinguishers are required they shall be multipurpose extinguishers and shall be located as requested by the risk assessment. If provided they shall be maintained in working order and residents instructed in their use.
Other Recommendations	Polystyrene ceiling tiles should not be used within the premises. Portable heaters using gas cylinders or flammable liquids should not be used or stored in the premises. Generally signage relating to fire precautions is not necessary. However fire doors across escape routes, communal kitchens, and boiler rooms should be marked 'Fire door keep shut'. Reference should be made to 'The Management of Houses in Multiple Occupation (England) Regulations 2006' – in particular regulation 4 relates to the maintenance of fire fighting equipment and alarms.

Plan 4, House Type: Typical three storey HMO with shared cooking facilities

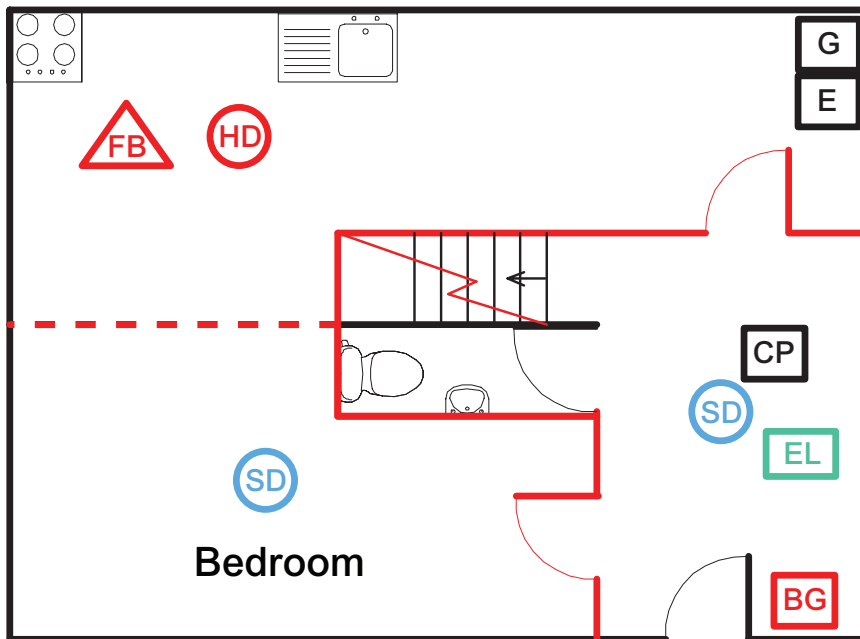

Ground Floor

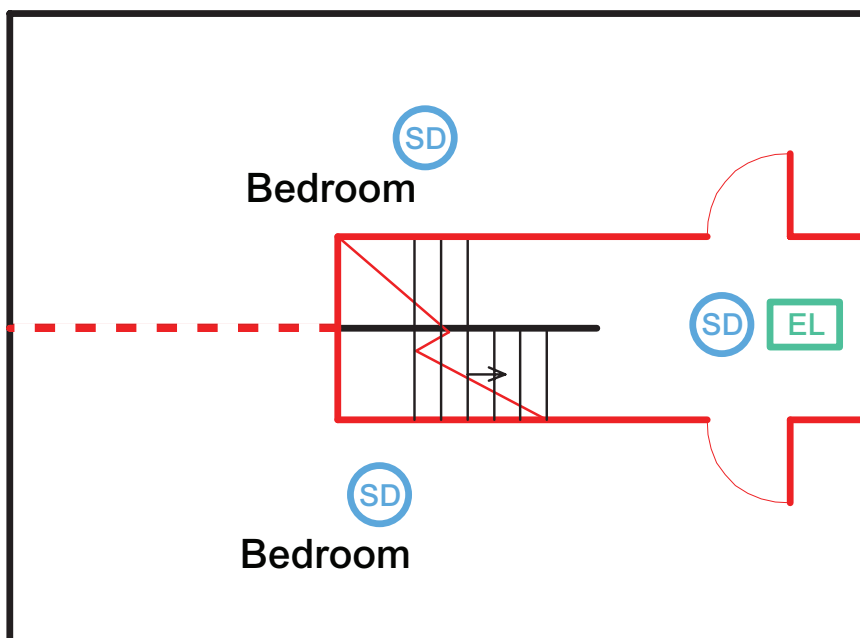

First Floor

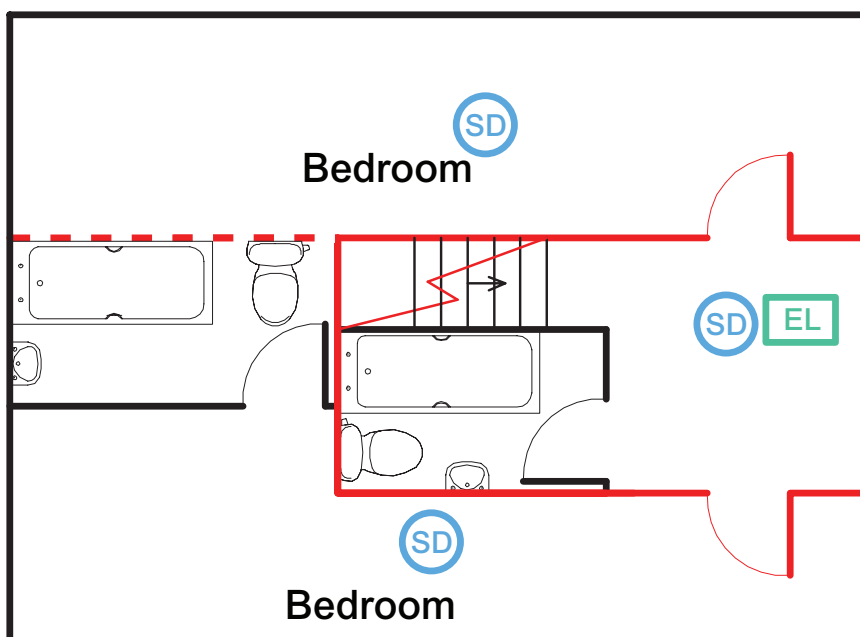

Second Floor

Outline requirements for example property - Plan 5

Detection/ Warning	A system of mains powered smoke detectors and heat detectors with battery back up and built in alarm to achieve BS 5839 Part 6: Grade D (or equivalent). Detectors must be sited in all areas containing a fire risk including the basement. In kitchens a heat detector rather than a smoke detector must be installed. All detectors must be interlinked so that if one detector is triggered, the alarm sounds in each and every alarm location. See page 29 for technical specification.
Call Points	Not required.
Control Panel	Not required.
Emergency Lighting	Conventional lighting is required throughout the escape route. Emergency lighting maybe appropriate if the route is complex or there is no effective borrowed light. The requirement for, and the degree of emergency lighting will depend on the design of the property and the location of the escape route and form part of the overall Fire Risk Assessment. Where considered necessary it must be designed and installed in accordance with BS 5266 part 1 (or equivalent). Refer to page 32 for technical specification.
Escape Route	The escape route should allow occupants from all parts of the building to reach a place of safety outside without passing through a higher fire risk area. The route should be kept free of obstructions and combustible materials at all times, and the walls and ceilings should be free of flammable materials such as polystyrene ceiling tiles and heavy flock wall paper. At least 30 minute fire resistance should be provided to the route as indicated by red on the accompanying plan. There is no requirement for additional fire separation between rooms, but the walls and floors must be of sound traditional construction. Ceilings between basement and ground floor escape route should be constructed to provide 30 minute fire resistance as indicated in blue on the accompanying plan. Electric and Gas meters located in the escape route should either be re-located or contained within fire resisting construction to provide at least 30 minute fire resistance. Refer to pages 32-39 for specifications relating to fire resisting construction.
Fire Doors	A fire door of at least 30 minute fire resistance must be installed in each doorway leading onto the escape route, except bathrooms and WC's (unless they contain a fire risk such as a boiler). Refer to page 40 for specification of fire doors.
Security of Doors	Security devices on bedrooms and final exit doors must be capable of being opened from the inside without the use of keys, i.e. Yale type or thumb turn locks.
Fire Blankets	A fire blanket should be provided in each area where there are cooking facilities, and be wall mounted 1.5m high adjacent to an exit door and away from the cooking appliance. These must comply with BS 6575 (or equivalent).
Fire Extinguishers	Where the risk assessment indicates that fire extinguishers are required they shall be multipurpose extinguishers and shall be located as requested by the risk assessment. If provided they shall be maintained in working order and residents instructed in their use.
Other Recommendations	Polystyrene ceiling tiles should not be used within the premises. Portable heaters using gas cylinders or flammable liquids must not be used or stored in the premises. Generally signage relating to fire precautions is not necessary. However fire doors across escape routes, communal kitchens, and boiler rooms should be marked 'Fire door keep shut'. Reference should be made to 'The Management of Houses in Multiple Occupation (England) Regulations 2006' – in particular regulation 4 relates to the maintenance of fire fighting equipment and alarms.

Plan 5, House Type: Typical two storey HMO with basement.

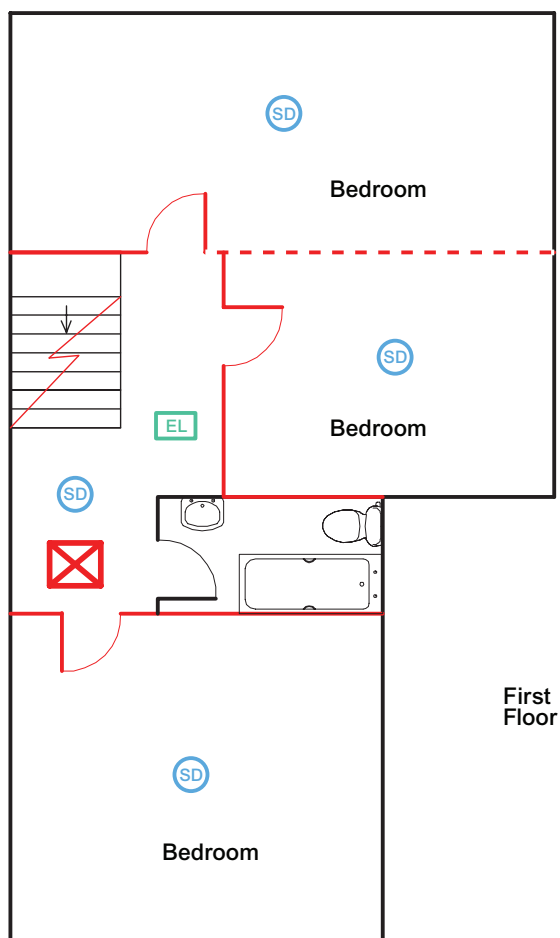
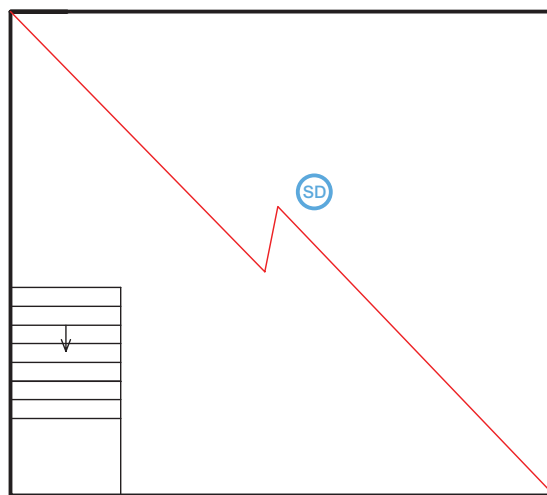
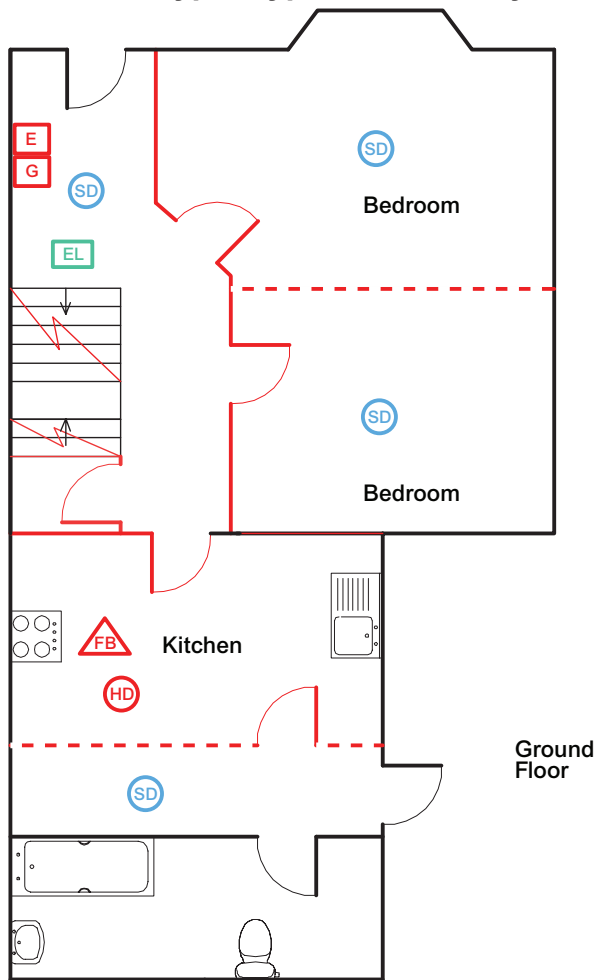

Outline requirements for example property - Plan 6

Detection/ Warning	A system of mains powered interlinked automatic smoke and heat detectors linked to a control panel with a built in alarm to achieve BS 5839 Part 6: Grade A (or equivalent). The main system to provide heat detectors in individual lets and smoke detectors in common areas and any storerooms/cellars. All detectors must be interlinked so that if one detector is triggered, the alarm sounds in each and every alarm location. In addition, to provide an early warning to occupiers of a fire occurring within their room, a single point mains wired smoke alarm is required, it is recommended that these have a hush facility. These detectors are not interlinked between rooms. Refer to page 29 for technical specification.
Call Points	Manual break glass points should be installed in numbers and positions determined by fire risk assessment. At least one should be installed close to the final exit of the of the escape route.
Control Panel	Must conform to BS EN 54: Part 2. Must be located in an easily accessible position within the escape route.
Emergency Lighting	Conventional lighting is required throughout the escape route. Emergency lighting maybe appropriate if the route is complex or there is no effective borrowed light. The requirement for, and the degree of emergency lighting will depend on the design of the property and the location of the escape route and form part of the overall Fire Risk Assessment. Where considered necessary it must be designed and installed in accordance with BS 5266 part 1 (or equivalent). Refer to page 32 for technical specification.
Escape Route	The escape route should allow occupants from all parts of the building to reach a place of safety outside without passing through a higher fire risk area. The route should be kept free of obstructions and combustible materials at all times, and the walls and ceilings should be free of flammable materials such as polystyrene ceiling tiles and heavy flock wall paper. At least 30 minute fire resistance should be provided to the route as indicated by red on the accompanying plan. There is no requirement for additional fire separation between rooms, but the walls and floors must be of sound traditional construction. Ceilings and walls between commercial and residential areas should be constructed to provide 1 hour fire resistance as indicated in blue on the accompanying plan. Electric and Gas meters located in the escape route should either be re-located or contained within fire resisting construction to provide at least 30 minute fire resistance. Refer to pages 32-39 for specifications relating to fire resisting construction.
Fire Doors	A fire door of at least 30 minute fire resistance must be installed in each doorway leading onto the escape route, except bathrooms and WC's (unless they contain a fire risk such as a boiler). Refer to page 40 for specification of fire doors.
Security of Doors	Security devices on bedrooms and final exit doors must be capable of being opened from the inside without the use of keys, i.e. Yale type or thumb turn locks.
Fire Blankets	A fire blanket should be provided in each area where there are cooking facilities, and be wall mounted 1.5m high adjacent to an exit door and away from the cooking appliance. These must comply with BS 6575 (or equivalent).
Fire Extinguishers	Where the risk assessment indicates that fire extinguishers are required they shall be multipurpose extinguishers and shall be located as requested by the risk assessment. If provided they shall be maintained in working order and residents instructed in their use
Other Recommendations	Polystyrene ceiling tiles should not be used within the premises. Portable heaters using gas cylinders or flammable liquids must not be used or stored in the premises. Generally signage relating to fire precautions is not necessary. However fire doors across escape routes, communal kitchens, and boiler rooms should be marked 'Fire door keep shut' Reference should be made to 'The Management of Houses in Multiple Occupation (England) Regulations 2006' – in particular regulation 4 relates to the maintenance of fire fighting equipment and alarms.

Plan 6, House Type: Typical three storey HMO above commercial premises with cooking facilities in each let

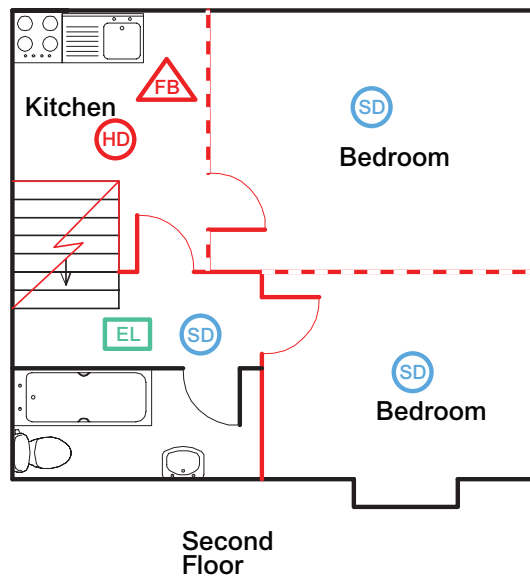
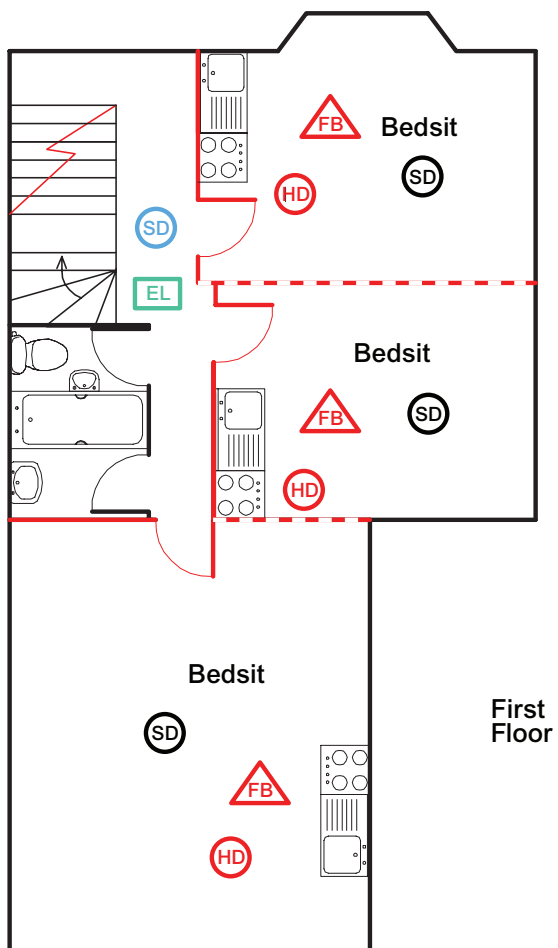
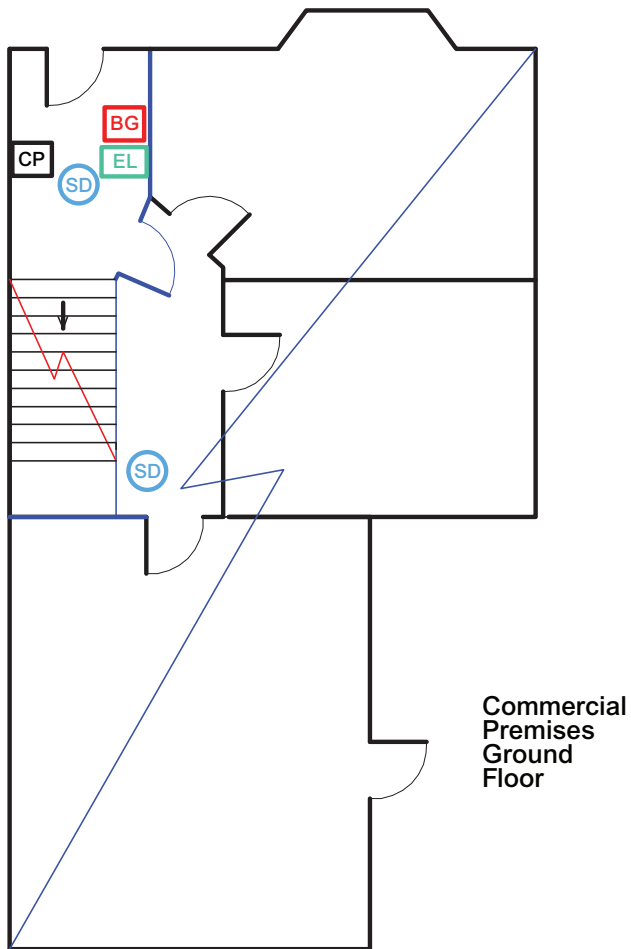

Part 5 - Management and Maintenance of Fire Safety

Whatever physical fire safety measures are provided in residential accommodation, their effectiveness will only be as good as their management and maintenance.

While single household dwellings will generally be self-managing, HMO accommodation will require ongoing attention to ensure fire safety measures remain effective. This section outlines management and maintenance measures applicable to HMOs. The responsible person (the licensee, landlord or managing agent) has a duty to ensure that the day-to-day management of fire safety in the premises is properly undertaken and that essential routine maintenance and emergency repairs are properly carried out. This is not only common sense and good practice, but also an obligation in law for those premises to which The Management of Houses in Multiple Occupation Regulations 2006 and The Regulatory Reform (Fire Safety) Order 2005 apply.

The level of management attention required will be determined as part of the fire risk assessment. Detailed recommendations are to be found in the HM Government Fire Safety Risk Assessment Sleeping Accommodation Guide. These recommendations may be appropriate in very large and complex buildings, but not all will apply fully for the average residential accommodation of normal risk covered by this guide.

Guidance on best practice in fire safety management can be found in BS 5588, part 12: 2004 Fire precautions in the design, construction and use of buildings – managing fire safety, but the points outlined below should be expected in any acceptable fire risk assessment as a minimum.

Escape routes:

- Must be free from obstruction at all times, and regular checks should be made to guarantee this;
- There should be no free storage on the escape routes;
- There should be no trip hazards such as trailing electrical leads or worn carpets;
- In most cases fire-resisting doors should be effectively self-closing to engage their latches with no obstructions or hindrances such as catching carpets. This will always be the case in bedsit-type HMOs. However, the requirement for self-closers is considered unnecessary in some situations, such as individual room doors within flats (the flat entrance door will still require one), within single household occupancies, and in smaller low-risk shared houses;
- All doors should be close fitting as designed. Fire doors should never be propped or wedged open. Any damage to fire doors should be noted and repaired. Any damaged or missing smoke seals must be replaced like-for-like.

Automatic fire detection (AFD) and warning systems:

BS 5839: part 1, section 6 contains recommendations for regular, routine testing of AFD systems as follows:

Grade A systems

- Routine testing – at least one detector or call point in each zone should be tested weekly to ensure correct operation of the system. Any defect should be recorded in the log book and action taken to correct it.
- Routine maintenance – a six-monthly service should be carried out by a competent person, usually a specialist alarm engineer, under a maintenance contract. It entails a full test to ensure compliance, as specified in BS 5839: part 1, section 6. It should be recorded in the log book and a periodic inspection and test certificate issued.

Grade D and E systems

- Routine testing – these systems should be tested every month by use of the test button on the smoke alarm.
- Routine maintenance – all alarms should be cleaned periodically in accordance with the manufacturer's recommendations.

All systems

- It is recommended that all detectors should be tested at least once a year to ensure that they respond to smoke. Tests should not involve the use of open flame or any form of smoke or non-specific aerosol that could contaminate the detection chamber or the electronics of the detector. Suitable specific test aerosols are available. The test is usually carried out by a specialist alarm engineer under a maintenance contract and should be recorded in the log book, with a periodic inspection and test certificate issued.

It is recognised that the above arrangements represent the ideal. While they may be possible in buildings with a resident landlord or a dedicated caretaker or housekeeper, in most situations for premises covered by this guide such arrangements may be impracticable. Where this proves to be the case tenants should be given clear instructions on how to test grade D or E alarms within their dwelling using the test button, along with clear recording and reporting instructions for any faults or false alarms on the system. Grade A systems are more specialist and resident testing will be inappropriate unless there is a trained individual in the property. Clear fault and false alarm reporting arrangements should be put in place, and the responsible person or his/her agent should respond to reports at the earliest opportunity.

Fire blankets and extinguishers:

- Where provided, these should be checked periodically to make sure they are in place and available for use. Extinguishers must be tested and maintained on an annual basis in accordance with BS 5306-3 and with the manufacturer's instructions.

Artificial lighting:

- Conventional staircase lighting must be working properly at all times. Any blown bulbs should be replaced and all switches should be working. If timer switches are fitted then the duration should be checked and adjusted if necessary;
- Any emergency escape lighting should be serviced and maintained in accordance with BS 5266-8: 2004 (BS EN 50172: 2004) Emergency escape lighting systems. This contains detailed recommendations which include inspections and tests to be carried out, down to a daily basis. For large, complex HMOs (such as those with five or six storeys) or premises with a specific high-risk factor (persistent vandalism problems, for example, or complex escape routes and no effective borrowed light), the full recommendations may be appropriate. However, in most average sized premises with normal risk, the following regime with a procedure for responding to reports of defects should be adequate:
- An annual discharge test in accordance with the requirements of BS 5266: part 8. This must be carried out by a competent person, usually a lighting engineer under a maintenance contract. It entails a full test to ensure compliance with the standard and should be recorded in the log book, with a periodic inspection and test certificate issued.

Water suppression systems:

- Where provided, the responsible person must ensure that any water suppression system is fully maintained and ready for use at all times. The landlord should enter into a maintenance contract with a competent person or company to maintain the system in accordance with clause 7 (maintenance) of BS 9251;
- The responsible person must ensure that the system is fully functional at all times and that any defects are rectified as soon as possible;
- The responsible person should check the pressure gauge readings monthly and record these readings in the systems log book. Any significant fluctuations or pressure readings below the agreed system design must be rectified immediately; and
- the system log book must be used to record all actuations, testing, maintenance, system faults and any remedial action.

Gas installations

- The Gas Safety (Installation and use) Regulations 1998 require that gas installations and appliances are maintained in safe condition and good working order and receive a gas safety check annually. The gas safety check and any other work to the installation may only be carried out by a competent and registered engineer. The findings must be recorded and the records kept for at least two years.

Electrical installations

- The electrical installation should be installed and maintained by a competent person and should be inspected periodically by a competent electrical engineer. An inspection every five years is recommended for all types of premises and is a legal requirement in HMOs under the Management of Houses in Multiple Occupation (England) Regulations 2006.

Electrical appliances:

- Letting agents and landlords should check all electrical appliances at the start of each new tenancy for defects (for example frayed wiring or badly fitted plugs) and remove any unsafe items;
- It is good practice to have the equipment checked at regular intervals thereafter, but there is no legal requirement to do so unless appliances are used by employees;
- Records should be kept of the checks carried out;
- Instruction booklets should be available at the property for all appliances and any necessary safety warnings should be given to tenants; and
- Second-hand electrical appliances should not be supplied, but if they are then they should be checked by a competent electrical engineer.

Furniture and furnishings regulations

- All furniture within lettings commencing after 1 January 1997 must meet fire resistance requirements. However, the regulations do not apply to furniture made before 1950 and re-upholstered furniture made before that date;
- all new furniture (except mattresses and bed bases) must carry a permanent label stating that it complies with the fire resistance standards. However, absence of such a label does not mean that the furniture does not comply, as the label may have been removed after the furniture was supplied. Some furniture manufactured before the regulations were applied may comply with the requirements anyway; and
- landlords and managing agents must ensure that the furniture supplied meets the fire resistance requirements, and the only practical way of doing so is to ensure that the furniture is labelled by the manufacturer in this way. If this cannot be ascertained then the furniture should be replaced.

Information and training:

- Each occupier should be given specific advice on fire prevention and fire safety in the home. This should be provided at the start of each new tenancy and reviewed periodically. Suitable advice can be found in annex one of BS 5588: part 12, Advice to occupiers of domestic residential buildings, and advice is also available from local fire and rescue authorities. Information should include:
 - An explanation of the escape routes, particularly where secondary means of escape is provided;
 - How the fire detection and alarm system operates and what to do if it activates;
 - How and when to re-set the fire alarm system;
 - If extinguishers or fire blankets are provided, training in their application and safe use;
 - Avoidance of false alarms;
 - How and when to call the fire brigade;
 - How to report defects;
 - The importance of maintaining clear escape routes, free of storage;
 - The importance of keeping fire doors closed, not propped or wedged open;
 - Smoking and cooking safety;
 - Gas safety advice;
 - Safe storage and disposal of refuse; and
 - The safe use of escape windows where appropriate.

Record keeping:

- It is recommended that a property log book is kept and all routine maintenance and servicing activity (as recommended in this guide) is recorded in it, along with all reported defects and remedial action taken – including false alarms. Model log books may be available from landlords associations or through landlord accreditation schemes.

Part 6 Technical Specifications

6A: Automatic Fire Detection and Alarm Systems

Fire Alarm System to Comply with Current British Standard 5839 Part 6: Grade A (or equivalent), LD2 category coverage*.

General

1. This comprises a system of electrically operated smoke and/or heat detectors, which are linked to a control panel to give information on the location of the fire or any fault, which may develop.

Control Panel

2. The control panel must conform to current BS EN 54: Part 2.

Call Points

3. These systems will normally incorporate manual break glass call points, located on each floor and at the final exit. The provision of break glass call points and their suitability should be assessed as part of the premises risk assessment.

* This document and your local Authority will generally not require the installation of call points on every level. You should however be aware that the alarm system will not comply fully with the BS.

Audibility

4. The alarm signal must achieve sound levels of: -
 - Not less than 65dB (A) in all accessible parts of the building.
 - Not less than 75dB (A) at all bed heads, to arouse sleeping persons when all doors are shut.

It is the responsibility of the installation contractor to specify the appropriate number and location of alarm sounders to achieve these sound levels.

Power Supplies

5. The power supply for a Grade A system should be a dedicated circuit, segregated from other electric circuits by distance, conduit, trunking or cable type. The system must have a 72 hour battery back up.

The circuit should have its own switch/fuse close to the origin of the supply, which must be labelled with its function.

Wiring

6. The wiring should be of fire resisting cable or protected from fire by 30 minute construction and should be monitored to give warning at the control panel in the event of open or short circuit.

Fire Alarm System to Comply with Current British Standard 5839 Part 6: Grade D (or equivalent), LD2 category coverage.

General

1. This comprises a system of one or more interlinked mains powered smoke and/or heat detectors each with an integral stand by battery and built in alarm.

Control Panel

2. A control panel is not required with this system.

Call Points

3. Call points are not required on a Grade D system.

Audibility

4. The alarm signal must achieve sound levels of: -
 - Not less than 65dB (A) in all accessible parts of the building
 - Not less than 75dB (A) at all bed heads, to arouse sleeping persons when all doors are shut.

It is the responsibility of the installation contractor to specify the appropriate number and location of alarm sounders to achieve these sound levels.

Power Supplies

5. The power supply for a Grade D system should be a dedicated circuit or be connected to a regularly used, electrically protected, local lighting circuit. All smoke alarms and heat detectors should be connected to the same final circuit. The system must have a 72 hour battery back up.

Wiring

6. Wiring should comply to IEE Regulations (BS 7671).

Radio-linked System

7. Radio-linked systems (also called wireless systems) are considered in both BS 5839 - part 1:2002 and BS 5839 - part 6:2004. A specialist fire alarm contractor will need to be consulted to confirm whether or not they can provide a system that meets the recommendations of the British Standards above.

General Requirements Common to Both Systems

■ **What type of smoke detector?**

There are three types of smoke detector currently on the market – ionisation, optical and combined. Optical detectors are generally more sensitive than ionisation for slow burning, smoldering fires that would be typical from foam filled upholstery. You should therefore opt to install optical or combined (detect smoldering and flaming fires) smoke detectors unless for instance a shower is present in the room. Further guidance can be sought from your installer and your Local Authority.

■ **Mounting Position**

Smoke/heat detectors should preferably be mounted on ceilings and should be located at least 300mm horizontally from any wall/beam or light fitting.

■ **Obstructions**

If the passage of smoke or hot gases to a detector is likely to be disturbed by a ceiling obstruction (such as a beam) having a depth greater than 150mm, then detectors should be provided on each side of the obstruction.

■ **Power Supply**

It is not acceptable to provide power to the fire precautions via pre-payment or coin operated electric meters. All control panels, consumer units and electric meters must be located in easily accessible locations within common areas of the dwelling i.e. not within bedrooms.

The manager is required to maintain the electric supply to the fire precaution system. Ideally this should be achieved by the installation of a dedicated electric meter that is under the control of the manager. Alternatively the contract to supply electricity should be under the control of the manager of the property.

■ **Mixed Use Buildings**

Where there is a mixture of residential and commercial use within the same building, the fire alarm system may be required to be installed in accordance with the current British Standard 5839 Part 1 (or equivalent). *Contact your Local Authority for further advice in these circumstances.*

■ **Certification**

Fire alarm systems must be installed by a suitably qualified electrical contractor. Upon completion, the contractor must provide an installation, commissioning and test certificate (see model certificate on next page).

Model Installation, Commissioning and Test Certificate

Model certificate for Grades B, C, D, E and F systems



This certificate is not valid if the serial number has been defaced or altered

FHN2 (B-F)/

TRACEABLE SERIAL NUMBER

CERTIFICATE OF DESIGN, INSTALLATION AND COMMISSIONING OF A FIRE DETECTION AND ALARM SYSTEM OF GRADE B, C, D, E OR F IN A DWELLING

Original (to the person or contractor who works)

DETAILS OF THE CLIENT		Issued in accordance with BS 5839-6: 2004.
Client:		
Address:		

DETAILS OF THE FIRE DETECTION AND ALARM SYSTEM		The system is
Address:		
Extent of the fire detection and alarm system covered by this certificate	<input type="checkbox"/> New <input type="checkbox"/> An addition <input type="checkbox"/> An alteration	

DESCRIPTION OF SYSTEM GRADE AND SYSTEM CATEGORY		Tick boxes as appropriate
System grade	<input type="checkbox"/> B <input type="checkbox"/> C <input type="checkbox"/> D <input type="checkbox"/> E <input type="checkbox"/> F	System category: <input type="checkbox"/> LD1 <input type="checkbox"/> LD2 <input type="checkbox"/> LD3 <input type="checkbox"/> PD1 <input type="checkbox"/> PD2

COMMISSIONING		See Note 1	A tick in the box indicates the inspection or test has been performed and the results are satisfactory. N/A indicates an inspection or test is Not Appropriate
Test buttons checked	<input type="checkbox"/>	Simulated smoke or aerosol test	<input type="checkbox"/>
All alarm warning devices operate	<input type="checkbox"/>	Heat test	<input type="checkbox"/>
Silencing system checked	<input type="checkbox"/>	Bedroom sound level (Clause 13.2)	<input type="checkbox"/>
		Dedicated circuit(s) provided	<input type="checkbox"/>
		Protective device labelled	<input type="checkbox"/>
		Audible and visual indication of mains failure	<input type="checkbox"/>
		Sound level test instrument used	See Note 2
		Model and serial No.	
		Serial No. of associated Electrical Installation Certificate or Minor Electrical Installation Works Certificate (See Note 1)	

USER INSTRUCTIONS		Tick boxes to indicate that the written information has been issued to the user	
I/We the undersigned declare that the occupier* of the dwelling (or owner in the case of a house in multiple occupancy) has been provided with written information about essential aspects of the operation and maintenance of the system, as follows:			
Operation of the system	<input type="checkbox"/>	Routine testing of the system	<input type="checkbox"/>
Action to be taken in the event of a fire alarm signal	<input type="checkbox"/>	Service and maintenance of the system (including intervals at which any batteries should be replaced)	<input type="checkbox"/>
Avoidance of false alarms and action in the event of a false alarm	<input type="checkbox"/>	The need to keep clear space around all detectors and manual call points	<input type="checkbox"/>
Warning that apparent false alarm from carbon monoxide detector may not be false alarm	<input type="checkbox"/>	Special precautions relevant to any lithium batteries used in the system	<input type="checkbox"/>
		Checking the system on reoccupation of the dwelling after a vacation etc.	<input type="checkbox"/>
		The need to avoid contamination of detectors by paint	<input type="checkbox"/>
		As-fitted drawing	<input type="checkbox"/>

* In the case of a newly-built property and where the future occupier is unknown, the User Instructions should be issued to the builder for onward transmission to the purchaser together with the related electrical safety certificate.

CERTIFICATION OF DESIGN, INSTALLATION AND COMMISSIONING	
I/We, being the person(s) responsible (as indicated by my/our signature(s) below), for the design, installation, and commissioning of the fire alarm system, particulars of which are set out above, CERTIFY that the said work for which I/we have been responsible complies to the best of my/our knowledge and belief with the recommendations of BS 5839: Part 6 for the system described above, except for the variations, if any, stated below:	
Variations (if any):	
The extent of liability of the signatory is limited to the work described above as the subject of this certificate.	
For the DESIGN, INSTALLATION AND COMMISSIONING of the system:	This certificate has been reviewed by the Qualified Supervisor:
Signature: _____ Date: _____	Signature: _____ Date: _____
Name (CAPITALS): _____	Name (CAPITALS): _____

DETAILS OF THE APPROVED CONTRACTOR	
Trading Title:	
Address:	
	NICEIC Enrolment No (Essential information)
	Branch number (if applicable)
Postcode:	

Note 1. The electrical safety aspects of the fire detection and alarm system must also be certified in accordance with BS 7671: 'Requirements for Electrical Installations' by issuing an electrical safety certificate of a form which meets the requirements of BS 7671, such as a 'Domestic Electrical Installation Certificate' or, where appropriate, a 'Minor Electrical Installation Works Certificate'.

Note 2. An instrument complying with BS EN 61672: Class 2, with slow response and A weighting (see Clause 13.2), is suitable for measuring the sound level.

Note 3. This certificate may be required by an authority responsible for enforcement of the safety legislation, such as the building control authority or housing authority. The recipient of this certificate might rely on the certificate as evidence of compliance with legislation. Liability could arise on the part of any organization or person that issues a certificate without due care in ensuring its validity.

Please see the 'Notes for Recipient' on the reverse of this page.

6B: Emergency Lighting

Provision of an Emergency Lighting System to comply with parts of Current British Standard 5266 Part 1 (or equivalent)

This is a system of battery-powered lights, where the battery is continuously trickle charged from the mains supply. The lights are to be located on the fire escape route and are designed to operate if the local primary lighting sub-circuit fails, via a relay switch. The wiring should be carried out in twin and earth cable and power must be taken directly from the landlord's supply. A qualified electrical contractor must carry out the installation. Upon completion, the contractor must provide an appropriate certificate. The system must have a suitable means for simulating failure of the normal supply so that you can test the system. It will not normally be necessary to install emergency lighting in all the locations required by the BS 5266, but the lighting should cover changes in direction and level.

Note: For certain 2 storey properties (for example) where there is borrowed light and no back addition emergency lighting may not be necessary, this will be determined on a risk basis. If you have any queries please contact your Local Authority.

6C: Signs and Notices

Where the property has an unusual layout you may be required to display exit signs, your Local Authority will advise you on this. If you decide to or are required to display signs they should meet the following specification:

Clearly visible 'EXIT' exit signs comprising white figures on a green background should be provided within the stairwell at each landing level to clearly indicate the escape route from the building. Size 100mm x 500mm to comply with The Health and Safety (Safety Signs and Symbols) Regulations 1996. Exit signs above final exit doors shall be provided above alternative exit doors, for example above the rear door from the kitchen.

6D: Fire Resistance Of Walls And Partitions

Half Hour Resistance

1. New Walls And Partitions

Half hour fire resistance can be achieved by any of the following methods of construction:

Solid walls

- Masonry blockwork/brickwork 100mm thick (load bearing)
- Masonry blockwork/brickwork 75mm thick (non-load bearing)

Stud Partitions

The constructions given below apply to both faces of the wall or partitioning.

They are also suitable for infilling spandrels to staircases providing adequate studding has been incorporated into the wall:-

Partition walls to consist of a timber frame 75mm x 50mm minimum (non-loading bearing) with head and sole plates, studs at 600mm centres and facing each side of:-

- 12.5mm plasterboard finished with plaster skim
- 12.5mm fire rated plasterboard, unplastered
- Proprietary fire resisting insulation board installed in accordance with manufacturers specifications. **(See Diagram 1)**

Manufactured Partitions

Proprietary cellular core partition e.g Paramount board or equivalent installed in accordance with manufacturers specifications.

Note:

In all cases, where partition walls are to be left unplastered, the joints must be taped and filled using joint compound as recommended by the board manufacturer. Any gaps between the wall and surrounding structure should be filled flush using suitable fire resisting jointing compound.

Diagram 1

Example of fire resisting partitions

(half hour fire resistance)

The studding framework should be 75mm x 50mm and should be securely fixed where it joins floor, adjacent walls and true ceilings.

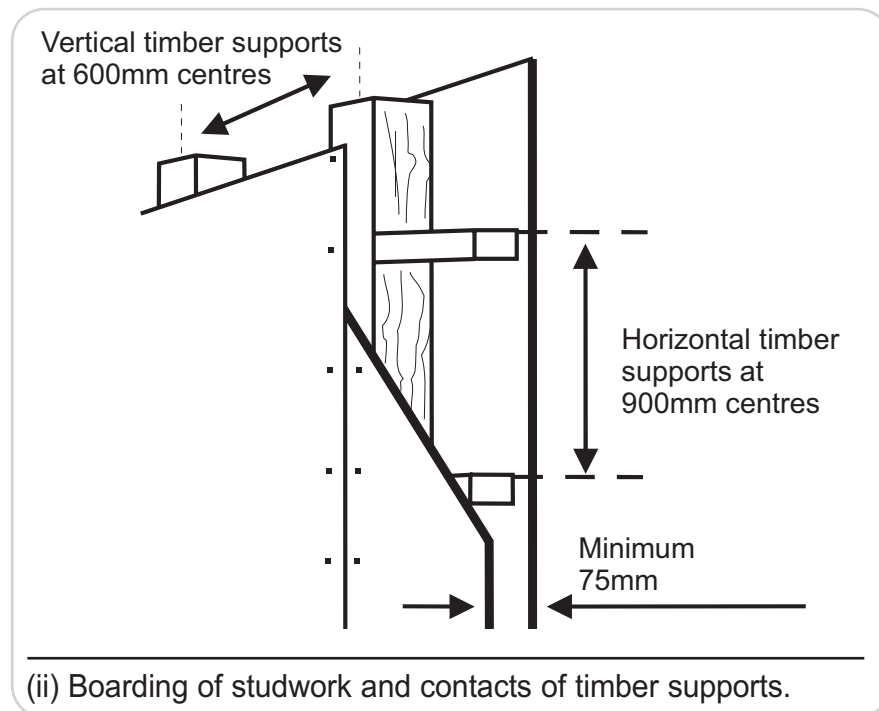
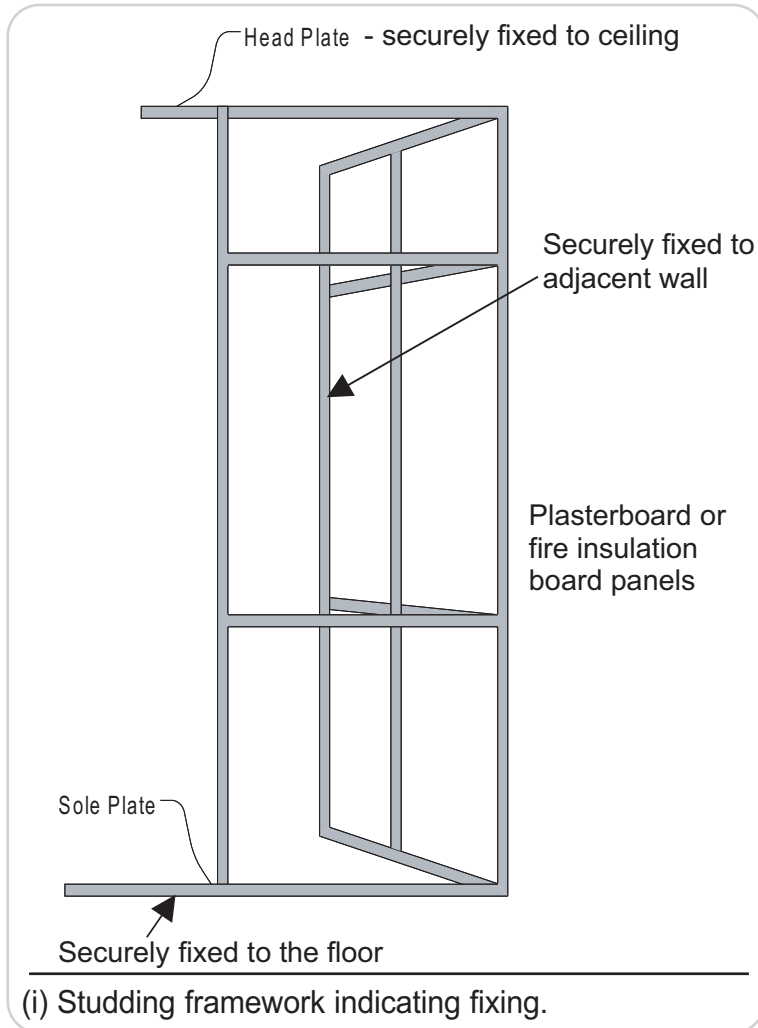

6E: Upgrading Existing Partitions to Achieve Half Hour Fire Resistance

The condition of the partition must be examined in detail. Retention of the partition surfaces must only be considered if in good condition and there is no loose or failing plaster or plasterboard.

In the event of minor damage or inconclusive investigation of the partition construction, the partition must be upgraded on the risk side (room side) by replacing the lath and plaster or unsound plasterboard, or by overboarding with 12.5mm gypsum wallboard or fireline board fixed with galvanised clout/plasterboard nails. These should have sufficient length to penetrate the lath and plaster or plasterboard, and provide a firm fixing in the timber framework. The partition should be finished by scrimming and skimming with plaster.

Particular care must be taken to ensure holes around pipework or ducts that pass through fire resisting partitions are fire stopped with materials that meet half an hour fire resistance. There are many proprietary fire stopping products available, but you must ensure that they have been tested and meet the appropriate part of BS 476 or BSEN 13501.

6F: Upgrading Existing Partitions to Achieve One Hour Fire Resistance

The following forms of Construction will provide 60 minutes fire resistance to Walls and Partitions

A: New Walls and Partitions

Solid masonry wall

- Masonry blockwork/brickwork 100mm thick (load bearing)
- Masonry blockwork/brickwork 75mm thick (non-load bearing)

Stud partitions

75 x 50mm timber load-bearing/non load-bearing stud partition. Studs at 600mm centres and no infill with the following facings on **both sides**.

- 2 x 12.5mm **Gypsum Wallboard** fixed with 40mm (1st layer) and 50mm (2nd layer) galvanised nails to every timber support at 150mm centres. The joints to be staggered, then taped and filled or surface scrimmed and skimmed.
- 15mm **Fire Resistant Gypsum Wallboard** (provided studs are 100mm x 50mm) fixed with 50mm galvanised nails to every timber support at 150mm centres. The joints to be taped and filled or surface scrimmed and skimmed.
- 9mm Supalux fillets, 75mm wide fixed to face of studs, 2 layers of 9mm Supalux, joints staggered with 50mm nails at 300mm centres. Fillets not required if partition is non load-bearing.
- Expanded metal lathing to BS 1369: Part 1: 1987 securely fixed to the timber studs. Plaster with 13mm lightweight Gypsum metal lathing type.

Where it is not possible to fix a facing on **both sides** of the partition, then **specifications 1 or 2** below can be used.

The specifications concern a non-load-bearing solid construction, which will provide a fire resistance of 60 minutes. They should only be used in constructions of up to 3 metres in height.

Specification 1

The partition consists of one layer of 20mm Supalux and one layer of 15mm Supalux. Vertical board joints are staggered nominally half the board width (i.e. typically 610mm) between the layers and the horizontal joints staggered by at least 300mm between layers.

32mm x 32mm x 20 gauge continuous mild steel angles are to be fixed with 32mm No 8 screws at 300mm centres into non-combustible plugs.

Fix 20mm Supalux to the angles with 32mm No 8 self-tapping screws at 300mm centres.

Fix the two layers together with 32mm No 8 self-tapping screws at 300mm centres on both sides of the horizontal and vertical joints.

Specification 2

Fix 25mm x 50mm x 0.8mm galvanised steel perimeter angle secured to the perimeter using steel screws or bolts and plugs at 500mm centres.

Fix 30mm self-drilling/tapping screws at 200mm centres. Secure 20mm layer of New Tacfire to perimeter angle.

Fix 35mm self-drilling/tapping screws at 300mm centres. Secure 15mm layer of New Tacfire to the first layer, around the perimeter and down the centre of each board.

Any joints in New Tacfire boards must be staggered by at least 350mm.

Existing Partitions

The following methods can be used to upgrade an existing (lath and plaster) partition made up of 75mm x 50mm timber studs which is either load-bearing or non load-bearing. The studs at maximum 600mm centres with no infill to provide a partition with 60 minute fire resistance.

Partitions can be upgraded in one of two ways:

By the provision of an additional board to the existing facing **on both sides**:

9mm Supalux fixed, on each side of the partition, using 63mm nails or screws at 300mm centres.

12mm New Tacfire fixed, on each side of the partition, using screws at 300mm centres. The length of the screws should be such that they penetrate 38mm into the stud.

By the provision of a cavity infill:

In this case it must be a non-load-bearing stud partition made up of minimum 89mm x 38mm studs at 600mm centres with no infill and covered with 12.5mm plasterboard.

Take off one face of the existing partition. Fill the cavity between the studs with 90mm Rockwool Timberbatts of density 23Kg/m³. Provide 12.5mm Gypsum Wallboard fixed at 150mm centres with 38mm galvanised nails. Joints must be taped and filled or surface scrimmed and skimmed.

Alternatively, if the timber studs are minimum of 100mm x 38mm at 600mm centres and covered with 12.5mm plasterboard the cavity between the studs can be filled with 100mm Rockwool RW2 slabs.

Any variations or alternatives to the above specifications must be agreed with your Local Authority prior to the works being carried out.

6G: The Upgrading of Floors and Ceilings

The floor and ceiling construction between floor levels in any house in multiple occupation must be able to resist the spread of smoke and flame from any fire.

1/2 Hour Fire Resistance

Confirm construction to be a minimum of 25mm square edge softwood boarding on 75mm x 50mm (7" x 2") softwood joists under drawn with 16mm (3/8") lath and plaster in sound condition. Overlay all floorboards above ground floor with minimum 4mm dense hardboard to total floor area.

Further information is available in Building Research Establishment Digest 208,

“Increasing the Fire Resistance of Existing Timber Floors.”

Other specifications are available and reference can be made to manufacturers' detailed specifications if supported by detailed fire test documentation.

Ceilings which are not in sound condition, particularly lath and plaster type, should be replaced or upgraded to provide 30 minutes fire resistance. This can be achieved by:

Removal and replacement of the existing ceiling with standard 12.5mm plasterboard & skim construction, or alternative product/construction providing 30 minutes fire resistance and subject to a satisfactory fire test report.

One Hour Resistance

The following forms of construction will provide 60 minutes fire resistance to ceilings

New Ceiling

The following boards when fixed to timber joists of minimum size 150mm x 50mm at max. 600mm centres with no infill and plain edged floorboards will provide 60 minutes fire protection.

- 2 x 15mm (or 12.5mm + 19mm) **Gypsum Wallboard** fixed with 50mm (1st layer) and 65mm (2nd layer) galvanised nails to every timber support at 150mm centres. Timber support includes the joists and minimum 38mm x 38mm noggins to span between the joists to support the board edges. The joints are to be staggered, then taped and filled or surface scrimmed and skimmed. The plain edge floorboards are to be overlaid with 3.2mm hardboard.
- 2 x 12.5 **Fire Resistant Gypsum Wallboard** fixed with 40mm (1st layer) and 50mm (2nd layer) galvanised nails to every timber support at 150mm centres. Timber support includes the joists and minimum 38mm x 38mm noggins to span between the joists to support the board edges. The joints to be staggered, then taped and filled or surface scrimmed and skimmed.
- 2 x 12mm Supalux, joints staggered, fixed with 63mm x No 8 screws at 300mm centres. Existing plain edge floorboard is to be overlaid with 4.8mm hardboard.

Existing ceilings

The following methods can be used to upgrade an existing (lath and plaster) ceiling made up of plain edge floorboards nailed to joists of minimum size of 150mm x 50mm at 600mm centres with no infill to provide a ceiling with 60 minutes fire resistance.

Ceilings can be upgraded in one of two ways:-

- By the provision of additional protection below the existing surface (i.e. room side)
- By the provision of additional protection above the existing ceiling i.e. within the floor space.

It is essential to ensure that if the existing ceiling is to be retained and upgraded, particularly if additional protection is to be provided within the floor space, that any gaps in the structure are properly sealed.

■ Protection below the Existing Ceiling

The plain edge boards are to be overlaid with 3.2mm hardboard. The existing ceiling is to be supported by chicken wire or expanded metal lathing of 25mm mesh, securely nailed to the joists. 38mm x 38mm noggins must also be fixed to span between the battens to support the following board edges:-

Two layers of 12.5mm **Fire Resistant Gypsum Wallboard** joints staggered.

or

Two layers of 10mm Glasroc Multi-Board with joints staggered.

The plain edge floorboards are to be overlaid with 4.8mm hardboard. The existing ceiling is supported with chicken wire or expanded metal securely fixed to the joists. 12mm Supalux is fixed through the existing ceiling to the joists with 63mm x No 8 wood screws at 300mm centres.

The plain edge boards are to be overlaid with 3.2mm hardboard. The existing ceiling is to be under-drawn with expanded metal lathing to BS 1369: Part 1: 1987 securely nailed to the joists. Plaster with 13mm (from face to lath) lightweight Gypsum metal lathing type.

■ Protection above the existing ceiling

Take up, as necessary, the existing floorboards. Fix 100mm x 12.5mm thick strips of Glasroc Multi-Board to each side of the joists using 36mm Gyproc Drywall screws at 300mm centres. Lay 12.5mm Glasroc Multi-Boards on top of the strips. Relay the floorboards. Overlay the floorboards with 3.0mm hardboard.

Take up, as necessary, the existing floorboards. Lay 19mm Gypsum metal lathing plaster trowelled between the joists in conjunction with expanded metal lathing or chicken wire at mid thickness of the plaster and well turned up and fixed to the joist sides or continuous over the joists. To prevent staining polythene sheets should be laid on the back of the existing ceiling. Relay the floorboards. Overlay the floorboards with 3.2mm hardboard.

Take up, as necessary, the existing floorboards. Fix 2 x 75mm x 12mm Supalux strips to each side of the joists with 50mm x No 8 screws. Lay 12mm Supalux cut, to be a tight fit, between the joists on top of the strips. Superlux to be overlaid with 80mm x 20Kg/m³ Rockwool Rollbatts. Relay the floorboards. Overlay the floorboards with 4.8mm hardboard.

Great care needs to be taken at the junctions between floors and walls, particularly where the floor construction is to be upgraded by providing additional protection within the floor space. The gap should be sealed between the adjacent joist and partition wall and the gap between the floorboards and skirting boards with **intumescent** paste.

For guidance on achieving 1-hour fire resistance to suspended ceilings, advice should be sought from an Environmental Health Officer.

Any variations or alternatives to the above specifications must be agreed with your Local Authority prior to the works being carried out.

6H: Fire Resisting Glazing in Walls and Partitions

For the purpose of this document glazing can be used to give periods of fire resistance of up to one hour, the actual fire resistance is determined by the nature and dimensions of the glass, the type of frame and method of securing the glass.

The limitations on the use of uninsulated fire-resisting glazing for Building Regulation purposes are described below and it should be noted in this case that uninsulated fire-resisting glazing is not permitted between residential/sleeping accommodation and a protected corridor or lobby.

Wired glass should not be used in panes exceeding 1.2msq in area and should be 6mm thick for half hour fire resistance.

The design data for wired glazing in different frames is set out below and is applicable to glazed areas in walls and partitions.

The timber frame members and dividing bars should not be less than 56 mm deep and 44 mm wide with the rebate worked from the solid material. For the protection of timber beading intumescent paints have proved satisfactory.

See diagram 2 below for methods of fixing.

Method of fixing for Glazing in Walls and Partitions

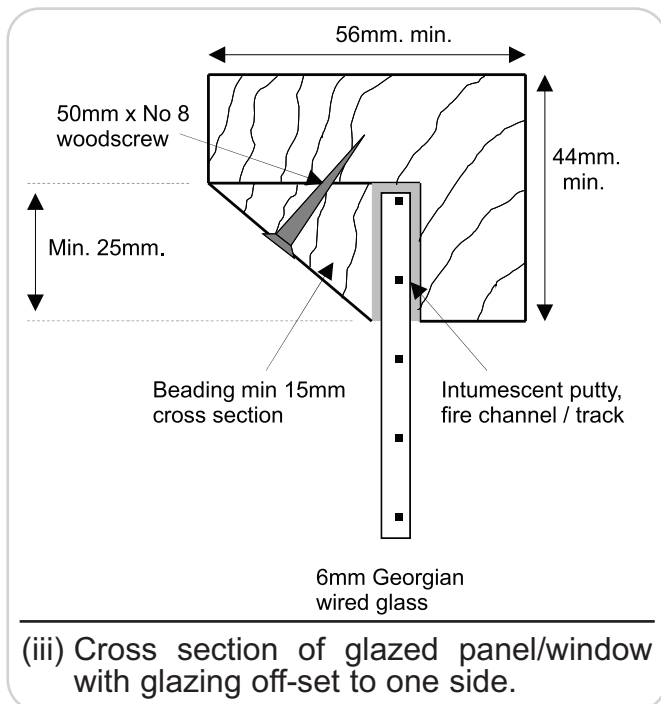
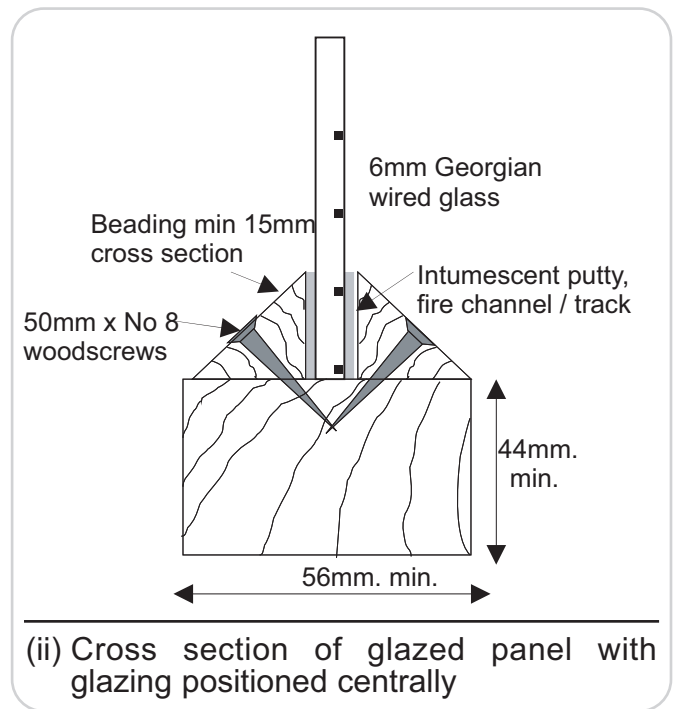
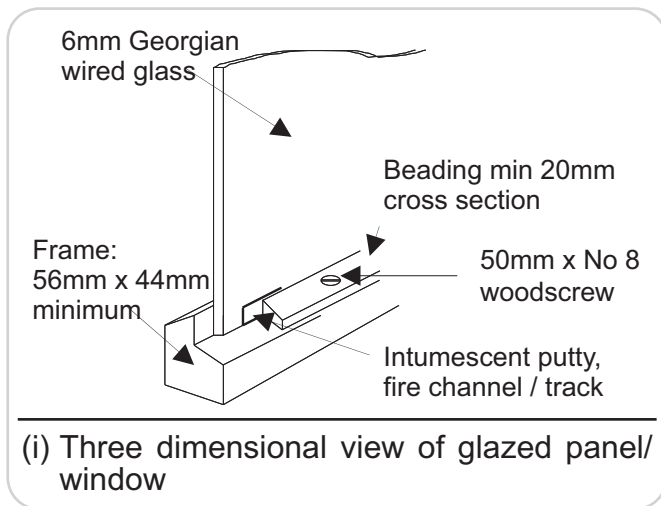

Note:
This guidance is for providing fire resisting glazing in partitions only. It does not relate to glazing in fire doors. A fire door has to be designed specifically to accommodate glazing. If glazing is required in a fire door then purpose made doors with glazing in situ should be obtained.

Safety Glazing

Glazing in critical locations (i.e. where there is a danger of falling through or of lacerations) may need to meet both fire resistance and safety standards i.e the use of fire resisting safety glazing complying with current British Standard 6206: 1981 (or equivalent). See Diagram 3 for critical locations of safety glazing.

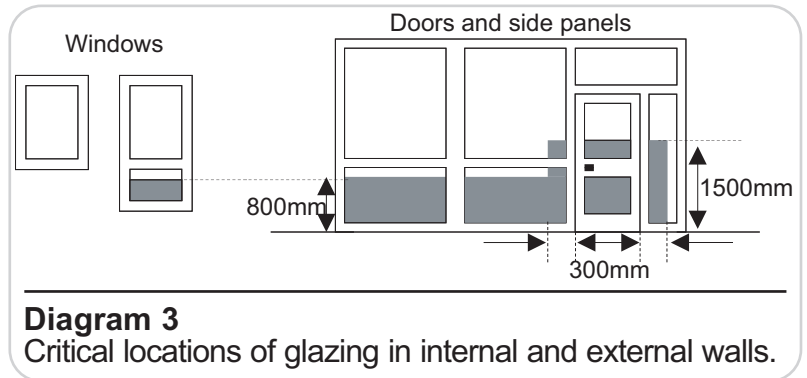

6I: Additional Escape Route Separation

Electricity or Gas meter on escape route

Provide ½-hour fire resisting enclosure to the electric and gas meter. Enclosure to consist of 100mm x 50mm softwood framing faced with 12.5mm plasterboard both sides or alternatively 6mm fire protective board (e.g. Supalux) to the inner side of the framework, scrim joints and apply minimum 3mm plaster skim to outer surface. Provide ½-hour fire resisting door. Where a fire door is to be cut down to fit a smaller door opening, then solid core ½-hour fire resistant door blanks only are to be used. Hardwood lippings are to be glued and screwed to leaf edges once the door blank has been cut down to the required size. Ensure points where pipes or cables penetrate the cupboard are tightly sealed with a non-combustible compound capable of maintaining the ½-hour fire resistant integrity of the cupboard structure (e.g. intumescent foam etc).

Lead pipes are unsatisfactory and the gas supply pipes should be of high melting point metal. The cupboard to the gas meter should be provided with ventilation grills at high and low levels, these must provide ½ hour fire protection. The gas provider should be consulted to ensure they are satisfied with the arrangements, as they will require access to read meters.

Loft Hatch

Loft hatches must provide the ½-hour fire resistance to the ceiling structure along the means of escape for the property.

Remove the existing loft hatch. Provide and fix suitable lining complete with minimum 25mm deep stops, both to be glued and screwed to loft hatch frame. Provide and fit ½-hour fire resistant loft hatch door to comprise solid core ½-hour fire door blank cut down to appropriate size, with hardwood lippings glued and screwed to each leaf edge. Provide and fit 10mm intumescent and smoke seals to be pinned into rebates on each leaf edge of the loft hatch door or alternatively into the loft hatch frame. The whole door to fit into the existing frame with no more than a 4mm gap at any point between the hatch door and the frame. 2-barrel bolts are to be provided and fitted on opposite sides of the exposed face to keep the hatch in a closed position under pressure when not in use.

Under stairs cupboard

The soffit and spandrel partition to the staircase is to be made ½ hour fire resisting. Apply to the existing soffit and spandrel 12.5mm plasterboard with 3mm skim coat, or 6mm minimum fire protective board (e.g. SUPALUX) with all joints filled with fire resisting compound. The cupboard below the stairs at ground floor level, in addition to the above, is to have all combustible materials removed. Fit new ½-hour fire resisting door and frame. The door is to be kept locked shut. Apply notice to door reading "TO BE KEPT LOCKED SHUT", to comply with The Health and Safety (Safety Signs and Symbols) Regulations 1996.

6J: Guidance on the Fitting of Fire Doors and Frames

½ Hour fire Resistance

Frames

Where new frames are provided the gap between the frame and wall should be infilled with suitable material to achieve 30 minutes fire resistance. The provision of architrave to cover gaps in this location will not provide the necessary fire resistance.

Doors

Failure of fire resisting doors is very often due to burn through at the gap between door leaf and door frame. The fit of the door to frame is therefore extremely important and the gap should be as small as practical allowing the door to close freely. In the case of fire doors fitted with heat (intumescent) and cold smoke seals (FD 30S) the gap should not exceed that stated by the seal manufacturer usually 3 to 4 mm maximum. Both seals shall be fitted along both vertical and top edges of the door.

- Doors should be hung on 1½ pairs (i.e. 3) x 100mm steel butt hinges.
- The positions for fitting seals in door leaves are shown in the diagrams below.
- Seals can be fitted in the frame and if so they should align with the centre of the door leaf. Manufacturers' instructions should be adhered to when fitting seals.
- Smoke seals **MUST NOT** be painted over as this reduces their flexibility and effectiveness.
- Seals are not required to be fitted across the bottom of doors, but the threshold gap should not exceed 8mm.

Ironmongery

- Voids around the locking mechanism must be kept to a minimum and filled with intumescent paste or be encapsulated with a proprietary intumescent product.
- All doors required for means of escape must be capable of being opened from the inside without the use of a key. (i.e Yale type or thumb turn locks).
- The door stop of the frame should not be cut away to facilitate any lock or latch.
- The door must be fitted with a self-closing device capable of closing the door into the frame from any angle. Hydraulic overhead closers conforming to current British Standard 476 Part 22 (or equivalent), current British Standard 6459 (or equivalent) and current British Standard 8214 (or equivalent) are preferable as they are more efficient and reliable.

Note: Some overhead closers are not suitable for use on fire doors so it is always best to check with the supplier or manufacturer before purchasing. Automatic closing devices and electromagnetic hold open devices will be considered as an alternative to the overhead or perco type door closers where this is supported by a risk assessment.

Where concealed closers are allowed on fire doors it is recommended that these should be of the double chain hydraulically powered type.

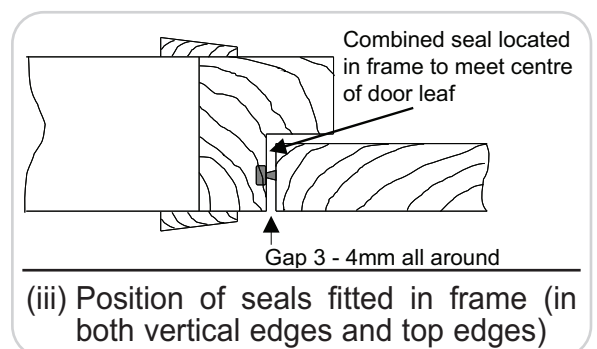
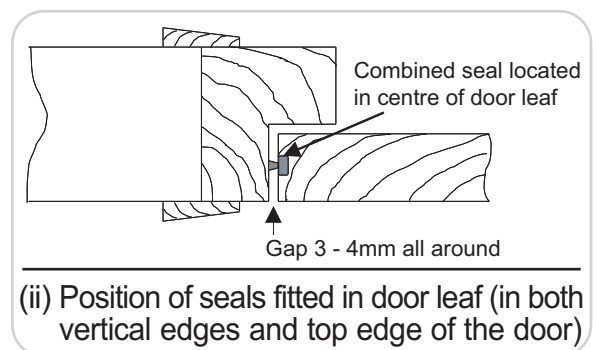
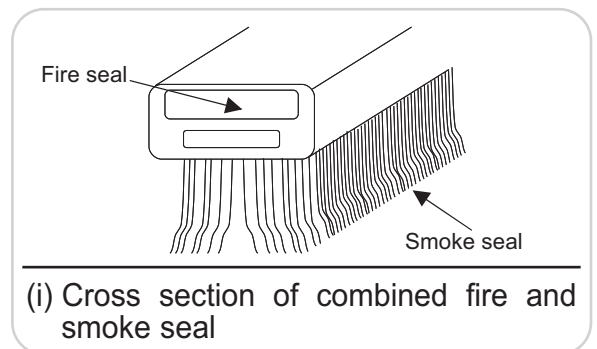

Diagram 1 Guidance on the fitting of combined fire and smoke seals.

6K: The Design of Escape Windows

Where window openings are likely to be used for means of escape purposes the following guidance must be referred to:

The window must have an unobstructed openable window area that is at least 0.33msq with at least the width or height dimension being a minimum of 450mm. Side hung opening lights are recommended. Care must be taken when considering the design (particularly with uPVC windows and their various hinge designs) to ensure the necessary openable area required is provided.

The bottom of the openable area (window cill level) must be not more than 1100mm, and not less than 800mm above floor level. Windows are suitable for means of escape where the drop from the window to ground level is one storey only (not exceeding 4.5m from first floor level to outside ground level).

Note: The ground below the windows must be flat and free from hazards (low walls, railings etc). Where security is provided on windows, means of opening must be readily available within the room. Where primary access to a sleeping room is through a high risk room (i.e. communal, kitchen or living room) an alternative suitable means of escape must be provided via a door or escape window directly to the outside.

Part 7 - Fire risk assessment

Introduction

All HMOs fall under the provisions of the Regulatory Reform (Fire Safety) Order 2005 (FSO) and are required to carry out a fire safety assessment. A properly conducted and recorded fire risk assessment will ensure that appropriate fire safety measures are put in place and will help demonstrate to enforcing authorities and the Courts / Tribunals that the person responsible for the HMO has taken their duties seriously. The responsible person may be the landlord or managing agent. It is good practice for fire risk assessments to be written and recorded although this is not always a legal requirement.

A Fire Risk Assessment is a tool that those responsible for multiply occupied properties can use to identify potential fire hazards, and enables them to take action to remove or reduce these hazards to as low a level as practically possible and then decide what physical fire precautions and management arrangements are necessary to ensure people's safety.

Guidance on fire risk assessments follows in this section. More detailed guidance can be found in HM Government Fire Safety Risk Assessment Sleeping Accommodation Guide, which is available on the CLG website at www.communities.gov.uk/firesafety or in the LACORS Housing Fire Safety Guide mentioned earlier.

1. What is a fire risk assessment?

- 1.1 A fire risk assessment is an organized and methodical look at the premises, the activities carried on there and the likelihood that a fire could start and cause harm to those in and around the premises. In most properties it will be straightforward to carry out a fire risk assessment, but in large or mixed use properties specialist advice may be required.
- 1.2 The aims of the fire risk assessment are:
 - to identify the fire hazards;
 - to reduce the risk to as low as reasonably practicable; and
 - to decide what physical fire precautions and management arrangements are necessary to ensure the safety of people in the premises if a fire does start.
 - “hazard” is anything that has the potential to cause harm and “risk” is the chance of that harm occurring

2. Suggested method for carrying out a risk assessment

- 2.1 The fire risk assessment should be carried out in a practical and systematic way and enough time must be allocated to the exercise. It may be useful to subdivide larger and / or mixed use premises into rooms or a series of assessment areas using natural boundaries (for example kitchens, offices and stores; and corridors, stairways and external routes).
- 2.2 The process can be broken down into five steps:
 1. Identify fire hazards (paragraph 2.3).
 2. Identify people at risk (paragraph 2.8).
 3. Evaluate, remove or reduce risk and protect against remaining risk (paragraph 2.12).
 4. Record, plan and inform or train (paragraph 2.15).
 5. Review (paragraph 2.19).

2.3 Step 1: identify the hazards within the premises

2.4 For a fire to start, three things are needed: a source of ignition, fuel and oxygen. If any one of these is absent, a fire cannot start. Taking measures to avoid the three coming together will therefore reduce the chances of a fire occurring.

2.5 Sources of ignition: these may include:

- smokers' materials such as cigarettes, matches and lighters
- naked flames, for example candles and night lights;
- electric, gas or oil-fired heaters (fixed or portable);
- boilers;
- cookers, toasters and other kitchen equipment (especially when shared);
- faulty or misused electrical equipment;
- electric blankets, computers, TVs, washing machines and dryers;
- lighting equipment (fixed and movable), for example halogen lamps and table lamps;
- the electrical installation itself; such as old and outdated wiring and fuse boxes and the overloading of electrical sockets
- the gas installation;
- arson attack;

2.6 Sources of fuel: these may include

- furniture, furnishings, textiles, bedding, clothing, curtains & laundry;
- accumulations of unwanted mail, waste paper, cardboard, newspapers and magazines (including that awaiting recycling collection);
- waste storage and refuse containers;
- flammable liquid-based products such as paint, varnish, thinners, adhesives, white spirit, methylated spirit and cooking oils;
- liquefied gas (LPG), paraffin, heating oils and petrol;
- decorations for seasonal and religious occasions;
- plastics and rubber such as videotapes, polyurethane foam-filled furniture and polystyrene-based display materials; and
- wall, floor and ceiling coverings and surface finishes.

Compliance with the regulations concerning gas, electrical and furniture safety will reduce the risk presented by some of the items listed above.

Particular care should be taken when premises are undergoing alteration, repair or redecoration. At such times flammable materials may be stored in the premises, possibly in escape routes or in rooms which are otherwise unused. Care should be taken as to where and how these products are stored. Premises which normally have good fire precautions and present a low fire risk may have their fire safety compromised by temporary careless storage of these products or by the disabling of fire precautions during the period of the works.

2.7 Sources of oxygen: in premises covered by this guide the oxygen source will be the air in the building. Where only normal natural domestic ventilation is provided the risk will generally be normal.

2.8 Step 2: Identify people at risk

2.9 Generally be residents and their visitors and anybody working in the premises such as a caretaker or cleaner and any visiting contractors. Only in buildings with mixed residential and commercial use are there likely to be other people to consider.

- 2.10 The risk assessment should consider people at risk, who may include:
- people asleep (who will be disorientated and slow to respond);
 - people who are unfamiliar with the premises (guests and visitors);
 - people with disabilities (including mobility impairment and hearing or vision impairment);
 - people who may have some other reason for not being able to leave the premises quickly (such as parents with young children);
 - people who are sensorially impaired due to alcohol, drugs or medication;
 - unaccompanied children and young people;
 - anyone working in enclosed, isolated parts of the building; and
 - anyone who has difficulty understanding English.

2.11 In evaluating the risk to people with disabilities it may be necessary to discuss their individual needs with them or seek professional advice.

2.12 Step 3: evaluate, remove or reduce risk and protect against remaining risk

2.13 Hazards should be removed where it is practicable to do so, and where they cannot be removed they should be reduced as far as possible. What is considered reasonable in a particular case will depend on an evaluation of the potential to cause harm and the chance of that harm occurring. Some simple examples are given below:

- replace portable heating appliances with fixed convector heaters or a central heating system;
- ensure electrical sockets are adequate in number and sited appropriately to avoid overloading and trailing leads;
- ensure electrical, mechanical and gas equipment is installed, used, maintained and protected in accordance with the manufacturer's instructions;
- ensure all furniture complies with the Furniture and Furnishings (Fire)(Safety) Regulations 1988;
- ensure combustible items such as furniture, laundry and decorations are stored properly and are kept away from potential ignition sources such as cookers, heaters and boilers;
- ensure refuse is properly stored and disposed of; and
- in crowded accommodation, provide adequate shelving and cupboard space so that everyday items are not in proximity to cookers or heat sources, e.g. heaters.

2.14 Having taken measures to remove or reduce fire hazards as far as is practicable, adequate fire precautions should be in place to warn people in the event of a fire and to allow them to escape to a place of safety. The general principles of fire risk reduction are outlined in the rest of this guide, where guidance is also given on what measures should be implemented and to what standards, based on overall fire risk assessment.

2.15 Step 4: record, plan, inform, instruct and train

2.16 It is a good idea for everyone to keep a written record of their fire safety risk assessment, and if the property is subject to the FSO the law says you must make a written record of your risk assessment. In these cases it is the “significant findings” of the risk assessment that must be recorded. Significant findings are the actions to be taken as a result of the assessment and details of anyone at particular risk. Significant findings should include details of:

- the fire hazards that have been identified (but ignore trivial things such as a tube of solvent-based glue);
- the actions taken, or which will be taken, to remove or reduce the chance of a fire occurring (preventive measures);
- persons who may be at risk, particularly those especially at risk;
- the actions taken, or which will be taken, to reduce the risk to people from the spread of fire and smoke (protective measures);
- the actions people need to take if a fire occurs. For most HMOs this will simply be to evacuate the property in the case of a fire and to summon the Fire & Rescue Service
- any information, instruction and training identified as being needed, and how it will be given; and
- any discussions that have taken place with residents (or, if appropriate, with staff).

2.17 It is recommended that a record of the significant findings of the fire risk assessment is kept in all cases, even where it is not a requirement to do so. An example template is shown below, and a blank template for you to use can be found at the end of this document, however, any alternative format will be acceptable provided it contains the information above.

2.18 An appropriate emergency plan should be put in place. In most residential accommodation this is unlikely to extend beyond advising residents what to do in the event of a fire or fire alarm and how to contact the fire and rescue service. In large or mixed use premises a more sophisticated plan may be necessary.

2.19 There is no requirement under the FSO to provide training to residents, but providing them with basic information on fire precautions is a simple and effective way of reducing fire risk in the premises.

2.20 Step 5: review

2.21 The risk assessment and the general fire precautions in the premises should be reviewed regularly. There is no specific timescale for this other than where there is a reason to suspect that it is no longer valid or where there has been a significant change in the premises.

2.22 In practice the fire precautions should be kept under constant review. Where problems are identified they should be dealt with as soon as possible.

3. Example Risk Assessment

3.1 Below is an example of risk assessment for a HMO that would be subject to mandatory licensing. The example is not exhaustive and is intended to give the responsible person an idea of what a fire risk assessment could look like. A blank fire risk assessment is reproduced at the end of this guide that you may like to use.

Risk Assessment – Record of significant findings

<p>Risk assessment for</p> <p>Building: 23 Acacia Avenue Anytown Hertfordshire</p>	<p>Assessment undertaken by</p> <p>Date: 22 January 2009 Completed by: John Smith Signature: J Smith</p>
<p>Property description: Three storey semi detached house, with five bedrooms, bathroom, WC, & kitchen</p>	<p>Use: Residential property occupied by five individuals.</p>

Step 1 - Identify fire hazards

Sources of ignition	Sources of fuel	Sources of oxygen
Cooking Smoking materials Electrical Installation Gas Installation Candles	Furniture Floor & wall coverings Polystyrene ceiling tiles Accumulation of junk mail	None other than naturally occurring

Step 2 - People at risk

Residents and visitors to the property

Step 3 - Evaluate, remove, reduce and protect from risk

<p>What is the risk?</p> <p>Who is at risk?</p> <p>Action taken to remove and reduce the hazards that may cause a fire</p> <p>Action taken to remove and reduce the risk to people from a fire</p>	<p>Risk from cooking higher than single family home as each resident cooks independently. Smoking permitted in the house</p> <p>Fire can spread throughout the property and all tenants and guests at risk, particularly at night when asleep.</p> <p>Smoking banned within the property Candles banned within the property Junk mail re-cycled Polystyrene ceiling tiles removed and replaced Electrical Installation tested for safety Gas Installation tested for safety Furniture replaced to comply with fire regulations where necessary AFD Grade A LD2 installed</p> <p>Tenants told how to use fire blanket in kitchen and extinguishers Tenants informed not to interfere with self closers on doors. 3 self closers adjusted so doors close properly</p>
--	---

Assessment review

Assessment/review date	Completed by	Signature

Landlord Fire Precaution Records

This will help to provide evidence of your management and ongoing maintenance of the property. It can be used in conjunction with your fire risk assessment and is a tool that will enable you to note and record changes in the property which may in turn affect the hazards and risks of fire in the property.

Fire Doors - must close completely from a 45° angle when room windows closed, intumescent and smoke seals must be fitted correctly.

Common Parts – must be kept clean, in good repair and free from obstructions. Any structural defects should also be noted and repaired – eg. Hole in wall.

Fire alarm – routine testing of call points and detectors. An inspection every 6 months by a competent electrician is required for BS 5839 Part 6 Grade A systems with a control panel or annually for Grade D (no control panel). All false alarms shall also be recorded.

Emergency Lights – a test key may be provided by the installer, alternatively you may turn the electricity off at the mains. Consult the system handbook.

January	Date Checked	Defects found	Actions Taken and date
Fire Doors			
Common Parts			
Fire Alarm			
Emergency Lights			
Other			
Signature of manager			
February	Date Checked	Defects found	Actions Taken and date
Fire Doors			
Common Parts			
Fire Alarm			
Emergency Lights			
Other			
Signature of manager			
March	Date Checked	Defects found	Actions Taken and date
Fire Doors			
Common Parts			
Fire Alarm			
Emergency Lights			
Other			
Signature of manager			
April	Date Checked	Defects found	Actions Taken and date
Fire Doors			
Common Parts			
Fire Alarm			
Emergency Lights			
Other			
Signature of manager			

May	Date Checked	Defects found	Actions Taken and date
Fire Doors			
Common Parts			
Fire Alarm			
Emergency Lights			
Other			
Signature of manager			
June	Date Checked	Defects found	Actions Taken and date
Fire Doors			
Common Parts			
Fire Alarm			
Emergency Lights			
Other			
Signature of manager			
July	Date Checked	Defects found	Actions Taken and date
Fire Doors			
Common Parts			
Fire Alarm			
Emergency Lights			
Other			
Signature of manager			
August	Date Checked	Defects found	Actions Taken and date
Fire Doors			
Common Parts			
Fire Alarm			
Emergency Lights			
Other			
Signature of manager			
September	Date Checked	Defects found	Actions Taken and date
Fire Doors			
Common Parts			
Fire Alarm			
Emergency Lights			
Other			
Signature of manager			

October	Date Checked	Defects found	Actions Taken and date
Fire Doors			
Common Parts			
Fire Alarm			
Emergency Lights			
Other			
Signature of manager			
November	Date Checked	Defects found	Actions Taken and date
Fire Doors			
Common Parts			
Fire Alarm			
Emergency Lights			
Other			
Signature of manager			
December	Date Checked	Defects found	Actions Taken and date
Fire Doors			
Common Parts			
Fire Alarm			
Emergency Lights			
Other			
Signature of manager			
ANNUAL CHECKS - Certificates must be kept detailing findings and contact details for the contractor			
	Date Checked & Company/Contractor details	Defects found	Actions Taken and date
Gas Safety			
Fire Alarm (Grade A system must be checked every 6 months)			
Electrical appliances			
Sprinkler System			

Part 8 – SPRINKLERS

Although fire sprinklers were invented in the UK in 1864 it was not until 1973 that their use for life safety was seriously investigated. Even since then the UK has not been proactive in extending and developing their use in residential premises despite many other countries passing local laws relating to them. Scottsdale in Arizona, introduced a requirement for sprinklers to be fitted to all new premises in 1985. The impact of this requirement was investigated after ten years and found that in properties with sprinklers there had been:

- No fire deaths
- 80% reduction in fire injuries
- 80% reduction in property damage
- 95% reduction for water usage for fire control

There is an extremely low risk of a false alarm with sprinklers and when one sprinkler is triggered it does not trigger any of the others. An auto dialler can be fitted to the system so that in the case of a sprinkler operating the call is transmitted to the fire brigade and the owner/manager automatically.

In short, should a fire occur the sprinkler suppresses the fire and douses it or contains it within that room. The damage that is caused by the water from the sprinkler is generally much less than the damage that would be caused by the fire, smoke and the water from the fire brigade in a property with traditional fire precautions. Sprinklers and associated pipe work can be fitted in the ceiling void and all that is visible is a small disc on the room ceiling.

One of the main advantages to the landlord is design freedoms. These may include relaxation of the requirement for fire doors allowing properties to maintain traditional features, increased travel distances and a reduction in structural fire protection. A risk based assessment will be made as to the individual requirements for each property and detailed below is an example specification.

Sprinkler Specification

A residential sprinkler system designed, installed and maintained in accordance with B.S. 9251 2005 should be provided throughout the premises. The sprinkler system is to be installed by a contractor approved by The Fire Sprinkler Association – a list of approved contractors is available from them on request. Alternative qualifications may be acceptable; you should contact your Local Authority for approval of your contractor.

The sprinkler system is to be linked to an automatic fire detection system and where a sprinkler head is activated the fire alarm system shall also be activated. The type of fire detection system required will depend on the type and layout of the building. Again, guidance should be sought from your Local Authority. Generally, the requirements will match those required in the examples given in Part 4 of this document, with the exception that heat detectors are not required.

When the sprinkler system is activated audibility levels of 75db(A) are to be achieved at the bedhead in each room (with the bedsit doors closed). As a guide only - sounders positioned in the common areas producing approximately 100db(A) should be capable of producing this sound level at the bedhead. Where the sprinkler system is linked to the fire alarm system 'common' sounders for the 2 systems can be used, although the sprinkler system must still have its own external visual and audio alarm and a single internal audio alarm.

A monitored link/autodialler shall be installed so that when a sprinkler head is activated either the Fire Service or the landlord/responsible person for the property is contacted. The link is only to be activated when the sprinkler system is activated **not** when the fire alarm system is activated.

When installation is completed the approved sprinkler contractor is to provide the documentation detailed in section 6.3.2 of BS 9251. A copy of this is to be provided for the Local Authority.

The landlord or responsible person is to enter into a maintenance contract with a competent person or company to maintain the system in accordance with section 7 of BS 9251. Details of maintenance are to be available at reasonable request.

A system logbook to record every event involving the system is to be kept accessible and maintained.

Part 9 - GLOSSARY

Some useful fire safety terms

AFD

Automatic fire detection and warning system. A system of interlinked smoke and heat detectors with integral or linked alarm sounders. The AFD system is designed to provide a reliable and constant means of detecting smoke or fire at the earliest possible stage and to sound an audible warning to occupiers, enabling them to escape before the fire develops to a dangerous stage. The sophistication and coverage of the system varies depending on risk. Design, installation and maintenance of AFD systems for premises covered in this guide are laid down in BS 5839: part 6, 1995.

Area of high fire risk

Room or other area which, because of its function, use or contents, presents a greater risk of fire occurring and developing than a standard risk room or elsewhere – for example large kitchens, boiler rooms and large storerooms.

Back-up supply

See stand-by supply

Bedsit HMO

A building which has been divided into individual non-self-contained lettings, let to unconnected individuals. Each bedsit letting will usually comprise only one room (sometimes more) which may contain cooking/food preparation facilities, washing facilities and living/sleeping space. Usually bathrooms and WCs are shared between a number of bedsits. The actual facilities contained within each bedsit letting will vary from property to property.

Circulation spaces

Passages, corridors, landings, hallways, lobbies and stairways.

Competent person

A person suitably trained and experienced so as to be able to properly examine, test and undertake any remedial action and to present the information in a report.

Competent and registered engineer

A person who is competent to inspect gas installations and provide a gas appliance test certificate. Specifically an engineer recognised by the Gas Safe Register as being competent to undertake such testing.

FD30 / FD30S

Purpose designed and built fire-resisting door assemblies with a minimum fire resistance of 30 minutes. The 30 figure indicates the door's performance time in minutes. A letter 'S' after the figure denotes a requirement for smoke seals to be fitted so as to restrict the passage of smoke, including cold smoke. Tested to either British or European standards.

Fire risk assessment

An organised and methodical look at a premises, the activities carried on there and the likelihood that a fire could start and cause harm to those in and around the premises. A requirement in premises to which the Regulatory Reform (Fire Safety) Order 2005 (FSO) applies, (i.e. those with common parts).

FRA

Fire and rescue authority.

FSO

The Regulatory Reform (Fire Safety) Order 2005.

Final exit

The termination of an escape route from a building giving direct access to a place of safety such as a street, passageway, walkway or open space, and sited to ensure that persons can disperse safely from the vicinity of the effects of fire.

Fire-resisting door

Complete construction of door, frame, all door hardware (and assemblies intumescent products and smoke seals where appropriate) which has been tested to prove its fire resistance performance to a particular standard. See FD30 above.

Fire test report

The documentation received from a testing house detailing a test carried out on a particular product or construction and the fire resistance performance achieved by the product/construction in that test.

Flat in Multiple Occupation (FMO)

A self-contained flat occupied by persons who do not form a single household.

High fire risk

See 'area of high fire risk' above.

HMO

House in multiple occupation, as defined in section 254 of the Housing Act 2004.

Intumescent strip

A strip of special material fitted around the edges of a fire door which swells to several times its original volume when subjected to heat. During a fire it will expand to fill the gap between the door and the frame providing a fire, heat and smoke resistant seal, thereby improving the door's fire resistance.

LHA

Local housing authority.

NICEIC

National Inspection Council for Electrical Installation Contracting.

Nuisance alarms

Alarms sounding in a system not caused by a genuine fire – may result from poor system design, occupier behaviour or a fault in the system.

Person having control

The person who receives the rack rent of the premises (whether on his own account or as an agent or trustee of another person) or would so receive it if the premises were let at a rack rent (Housing Act 2004, section 263).

Person managing

The person who, being an owner or lessee of the premises:

- (a) receives (whether directly or through an agent or trustee) rents or other payments from—
- (i) in the case of a house in multiple occupation, persons who are in occupation as tenants or licensees of parts of the premises; and
 - (ii) in the case of a house to which part 3 applies (see Housing Act 2004 section 79(2)), persons who are in occupation as tenants or licensees of parts of the premises, or of the whole of the premises; or
- (b) would so receive those rents or other payments but for having entered into an arrangement (whether in pursuance of a court order or otherwise) with another person who is not an owner or lessee of the premises by virtue of which that other person receives the rents or other payments; and includes, where those rents or other payments are received through another person as agent or trustee, that other person.

Pictogram

A diagram conveying a message without the use of words.

Place of ultimate safety

A place outside of the building and away from it, where people will be safe and unaffected by the fire or its effects.

Plasterboard

A board of gypsum plaster enclosed between and bonded to two paper sheets.

Protected route

An escape route out of a building offering a degree of protection from fire and smoke emanating from rooms opening onto it. In premises covered by this guide it will typically be the usual staircase, landings and hallway of the house leading to a final exit. A protected route will provide varying degrees of protection from fire and smoke in accordance with risk (a 30-minute protected route, for example, will be enclosed with construction giving 30 minutes of fire resistance and containing 30-minute fire-resisting doors with smoke seals (FD30S)). Lower risk premises will have protected routes offering a lower standard.

Relevant persons

Relevant persons include anyone lawfully on the premises and those in the vicinity of the premises who would be affected by any fire at the premises.

Residential property tribunal (RPT)

The formal name given to a tribunal of two or three people set up by law under the provisions of the Rent Act 1977 and the Housing Act 2004. It is an independent decision-making body which is completely unconnected to the parties or any other public agency. The RPT is the tribunal which determines appeals against any enforcement actions taken under the Housing Act 2004. Weblink: www.rpts.gov.uk

Responsible person

The responsible person for the purposes of fire safety provision and maintenance at residential accommodation is the person having control, i.e. the landlord or person managing.

Risk analysis

An exercise to determine the level of risk of suffering harm from an activity based upon a range of criteria – see Part 7.

Risk room

A room with a function, use or contents presenting a risk of fire occurring and developing; typically kitchens, shared living rooms, bedsit rooms. A risk assessment may include bedrooms in some cases. Excludes bathrooms and WCs containing no fire risk. See also 'area of high fire risk'.

Room sealed appliance

A gas appliance whose combustion system is sealed from the room in which the appliance is located and which obtains combustion air from outside the premises, and which also vents the products of combustion to open air outside the premises. Most modern gas boilers are room sealed appliances.

Self-contained flats

The meaning within this guide relates to flats in single occupation with all amenities behind the front door.

Shared house

Where a group of people take out a joint tenancy agreement for the exclusive legal possession and use of a whole house including all bedrooms. Occupation is similar to that of a single family dwelling.

Significant findings

The actions to be taken as a result of a fire risk assessment and details of anyone especially at risk. Must be recorded in some cases (see Part 7).

Smoke seal/strip

A rubber or synthetic strip fitted around the edge of a fire door to restrict the passage of smoke between the door and the frame. Doors requiring a smoke seal have the letter 'S' after their performance time in minutes in their designation (for example FD30S). The smoke resistance of the door when fitted with the strip will have been tested to standards in BS476: part 31.1, 1983.

Soffit

Underside of staircase, balcony, architrave or arch.

Sound traditional construction

The house should be of sound conventional construction. In relation to partitions and ceilings an example of this would be 9mm plasterboard partitions or lath and plaster, where they are in good condition i.e. not cracked or blown.

Spandrel

A vertical partition enclosing a staircase (usually found on the ground floor enclosing a staircase to the basement, or in the basement enclosing a staircase to the ground floor).

Stand-by supply

Battery power to fire alarm or lighting systems which cuts in if mains power fails.

Storey

In this guidance, for the purposes of fire safety, when counting the number of storeys the reader should count all floors from the level of the final exit to the topmost floor (include mezzanines as storeys). Where the final exit is located on the ground floor (or raised ground floor) any lower ground floor/basement/cellar should not be counted. Therefore, a house with a basement, ground and two upper floors with its entrance/final exit at ground floor level should be counted as a three-storey house. Note: this is a different convention to that in the HMO licensing definition (which counts cellars/basements) as this guidance is considering the distance of travel to the final exit as a factor in determining fire risk.

Suitably qualified Person

See 'competent person'.

Test report

See 'fire test report'.

Voids

Unused empty spaces within a building.

Vulnerable group

The HHSRS Operating Guidance defines a vulnerable group as "a range of people for whom the risk arising from a hazard is greater than for any other group in the population." It is restricted to age groups, no other vulnerability is considered. The assessment of likelihood of an occurrence resulting in harm is assessed based on a member of this group living in the property. For the hazard of fire, the vulnerable group is persons over the age of 60. The vulnerable group is only used to assess the hazard – when it comes to enforcement decisions then the actual person living there is considered.

Where necessary

The Regulatory Reform (Fire Safety) Order 2005 requires that fire precautions should be provided (and maintained) "where necessary". This means those which are needed to reasonably protect relevant persons from risks in case of fire. This will be determined by the findings of the risk assessment, including the preventative measures being taken. In practice, it is very unlikely that a properly conducted fire risk assessment, which takes into account all the matters relevant for the safety of persons in case of fire, will conclude that no fire precautions (including maintenance) are necessary.

Risk Assessment – Record of significant findings

Risk assessment for Building:	Assessment undertaken by Date: Completed by: Signature:
Property description:	Use:

Step 1 - Identify fire hazards

Sources of ignition	Sources of fuel	Sources of oxygen

Step 2 - People at risk

Residents and visitors to the property

Step 3 - Evaluate, remove, reduce and protect from risk

What is the risk? Who is at risk? Action taken to remove and reduce the hazards that may cause a fire Action taken to remove and reduce the risk to people from a fire	
---	--

Assessment review

Assessment/review date	Completed by	Signature
------------------------	--------------	-----------